



**SPEED-X™**

**User manual**

Version 2.6

# General index

1. [Hello](#)
2. [Safety](#)
3. [Your Digital.ID™ oven](#)
4. [Basic concepts](#)
5. [Basic concepts for cooking](#)
6. [Basic concepts for water treatment and washes](#)
7. [Apps](#)
8. [Oven cleaning and maintenance](#)
9. [Using the oven with the Digital.ID App™](#)
10. [Hey UNOX!](#)
11. [Restarting, updating and resetting](#)
12. [Assistance and support](#)
13. [Copyright](#)

# 1. Hello

SPEED-X™ is the first ever self-washing combi speed oven: the perfect combination of quality and speed.

Unimaginable performance, no compromises.

This manual contains all the information you need to use this appliance at its best.

If you do not fully understand any of the contents, please contact UNOX for further information.

# 2. Safety

- [Symbols used in the manual](#)
  - [Safety information](#)
  - [Materials suitable for the cooking chamber](#)
  - [Information on disposal and recycling](#)
  - [Declaration of conformity](#)
-

# Symbols used in the manual

Symbol

Meaning

---



Read the instruction manual

---



Danger! Situation presenting immediate danger, or a hazardous situation which could cause injury or death.

---



Risk of fire!

---



Risk of electric shock!

---



Risk of burns

---



Electromagnetic radiation: do not open the compartments marked with this symbol

---

---

# Safety information

## General precautions



Failure to comply with the safety regulations, and any use or maintenance other than those indicated in this manual invalidates the warranty (for further details see [www.unox.com](http://www.unox.com), in the “Warranty” section), and relieves the manufacturer of all liability.

Keep this appliance out of the reach of children.

Cleaning and maintenance must be done by the user and NOT by children, especially where not supervised by an adult.

This appliance can only be used for cooking food in industrial and professional kitchens by qualified personnel, who have completed regular training courses. Any other use is not compliant with the scope of use and is therefore hazardous.

If the appliance is not working or if you notice any changes to the structure or operation, disconnect the electricity supply and contact an authorised UNOX customer assistance service. Do not attempt to repair the appliance yourself. For any repairs, please request UNOX original spare parts.

To ensure that the appliance is in perfect condition in terms of use and safety, maintenance and inspections should perform at least yearly by authorised service centre.

The appliance emits a sound level of below 70 dB.

UNOX reserves the right to make changes to improve the appliances and accessories at any time without advance notice.

Full or partial reproduction of this manual is forbidden without the consent of UNOX. The measurements provided are approximate and not binding. In the event of disputes, this document was originally written in Italian. UNOX is not responsible for any translation/interpretation errors.

---

# Precautions for the risk of burns and injury



While cooking and until all appliance parts have cooled, make sure to only touch the appliance control components or handle, because the external parts are extremely hot (temperature above 60°C | 140°F).

Cooking can only take place with the door closed, for safety reasons. If the door is opened, the oven stops temporarily and a message appears on the display. To resume cooking, close the door again.

Do not use the oven in microwave mode with the cooking cavity empty.

Using the appliance without anything inside may cause it to overheat and damage the components in the system that generates the microwaves. Any component faults or defects caused by using the oven in microwave mode with the cooking cavity empty, or in any other usage conditions that do not comply with these instructions, are not covered by the manufacturer's warranty.

In order to maintain optimum performance, do NOT open the door during cooking, especially if you are using the microwave function. If it is not possible to avoid opening the door, please do so very slowly and carefully, paying attention to the hot steam coming out of the oven cavity.

Wear appropriate protective thermal clothing and take great care when moving containers, accessories and other objects inside the oven cavity.

NEVER put any type of tray, hot or cold container, or other objects on top of the oven, even if it is turned off. DO NOT put highly flammable or heat-sensitive objects (e.g. plastic ornaments, lighters, etc.) near the appliance.

Leave at least 10 cm | 3.94" of free space around the oven.

The first time you use the appliance, some of the oils used for manufacturing may evaporate and produce fumes or unpleasant odours. These will gradually disappear as you continue to use the appliance.

Liquids or other foods should not be reheated in sealed containers, as these may explode.

To avoid burns, do not use containers filled with liquids or products that liquefy, heating up to higher levels than can be easily observed (Europe: IEC 60335-2-42: 2002 / AMD1: 2008)

If reheating beverages, these may reach boiling point and cause a delayed eruption. Be careful when handling the container.

The contents of any baby bottles and any baby food in jars must be mixed or shaken before consumption. Check the temperature to avoid scalding.

Only use utensils and containers that are appropriate for the chosen cooking mode (quick or traditional).

Microwave reheating eggs in their shells or whole boiled eggs could lead to a risk of explosion, even when reheating has finished.

---

# Precautions to avoid excessive exposure to microwaves



Do not attempt to use this appliance with the door open as this may lead to harmful exposure to microwaves. Do not circumvent or tamper with the safety systems.

Do not position anything between the front of the oven and the door. Do not leave dirt or detergent residues to build up on the seals.

Do not use the oven if it is damaged. The oven door must close correctly and there must be no damage to the following:

- door (curvature);
- hinges and catches (broken or loose);
- door seals and raised faces.

The oven must be adjusted or repaired by suitably qualified technical support staff only.

---

# Precautions for the risk of fire



Before using the appliance, make sure that there are no non-compliant objects (instruction manuals, plastic bags, etc.) or detergent residues inside the oven cavity. Also make sure that the flue is free of obstructions and that there are no flammable materials in the vicinity.

When reheating food in plastic or paper containers, check the oven. Risk of fire.

If you notice any smoke coming from the appliance, disconnect the appliance from the mains power supply and keep the door closed to extinguish any flames.

Do not place sources of heat (e.g. grills, fryers, etc.), highly flammable substances or fuels (e.g. diesel, petrol, bottles of alcohol, etc.) near the appliance.

The appliance must be cleaned daily, removing any food residue. Failure to carry out cleaning as indicated could cause the surfaces to deteriorate. This could reduce the life of the appliance and cause danger (if not removed, fats or food residue on the inside could catch fire).

Do not clean the appliance with a steam or pressurised water jet.

Do not use highly flammable food or liquids while cooking (e.g. alcohol).

---

## Precautions for the risk of electric shock



Do not open the compartments marked with these symbols. Only qualified personnel authorised by UNOX may access these compartments. Failure to observe this regulation invalidates the warranty (for further details see [www.unox.com](http://www.unox.com), in the “Warranty” section), and may cause damage or injury including death.

---

# Precautions for routine maintenance



Any routine maintenance must be performed:

- after disconnecting the appliance from the power supply and waiting for the capacitive components to discharge (approx. 5 minutes);
- after waiting for the appliance to cool down fully;
- only if you are in good mental and physical condition, and are wearing suitable personal protective equipment (e.g. heat-resistant rubber gloves, eye protection, dust mask (optional), etc.).

Carefully read the product safety data sheet before handling and using the detergent. NEVER touch the detergent with bare hands. The detergent must not come into contact with the skin, eyes or mucous membranes. In the event of contact with the detergent, refer to the safety data sheet.

When cleaning any component or accessory NEVER use:

- abrasive, pointy or sharp tools or cloths (abrasive sponges, scrapers, steel-bristled brushes, etc.);
- steam or pressurised water jets;
- abrasive or powder detergents;
- alkaline, aggressive, caustic or corrosive detergents (e.g. hydrochloric/muriatic or sulphuric acid or caustic soda).

These substances could cause permanent damage to the appliance surfaces and catalysts. Do NOT use these substances even when cleaning the appliance substructure or the floor under the appliance. The volatile emissions from these compounds may still cause damage.

Do not insert ANYTHING inside the oven during the washing cycle, otherwise the washing is ineffective.

Do NOT open the oven door during a wash cycle as this could cause injury to eyes, mucous membranes and skin because of contact with the cleaning chemicals used. These chemicals are sprayed by the rotor in the cavity and moved by strong air currents.

Do NOT allow children to clean the appliance, especially when unsupervised by an adult.

Do NOT tamper with the detergent tank, its connections to the oven and the internal and external water circuit for any reason as this could cause a risk of injury or death.

Periodically check for rust stains inside the oven cavity: if any are found, contact a service centre urgently because the water is probably damaging the oven; prompt action will extend the lifespan of the equipment.

---

# Materials suitable for the cooking chamber

| <b>Cooking utensil</b>                      | <b>Permitted</b> | <b>Notice</b>   |
|---|------------------|---|
| <b>Heat resistant containers</b>            |                  |   |
| Toughened glass                             | Yes              |   |
| Compatible vitreous ceramics                | Yes              | Do not use items with metallic decoration                   |
| Earthenware (porcelain, crockery and china) | Yes              |   |
| <b>Metals, foils and plastics</b>           |                  |   |
| Metallic and foil trays and containers      | No               |   |
| Dual-ovenable plastic containers            | No               |   |
| <b>Disposables</b>                          |                  |   |
| Combustibles (paper, card, etc.)            | No               |   |
| <b>Other utensils</b>                       |                  |   |
| Tie tags                                    | No               |   |
| Cutlery                                     | No               | Do not leave utensils in a food product while it is cooking |
| Temperature probes                          | No               |   |

# Information on disposal and recycling

Pursuant to article 13 of Italian Legislative Decree 49 of 2014 “Implementation of the WEEE Directive 2012/19/EU on waste electrical and electronic equipment”

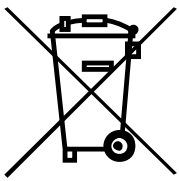

The crossed-out wheeie bin symbol specifies that the product was placed on the market after 13 August 2005 and that at the end of its useful life it should be collected separately and not disposed of with other waste. All appliances are made with recyclable metal materials (stainless steel, iron, aluminium, galvanized steel, copper, etc.) in percentages above 90% by weight. Before disposal, ensure the appliance is unusable by removing the power cable and all compartment or cavity closure devices (where present). At the end of its useful life, the product must be disposed of in such a way as to reduce any negative impact on the environment and make efficient use of available resources. Prefer prevention, preparation for reuse, recycling and reclamation, and remember “the polluter pays”. Please remember that illegal or incorrect disposal of the product incurs penalties, as provided for by current legislation.

---

## **Information on disposal in Italy**

In Italy, WEEE appliances must be delivered to:

- recycling centres (also known as waste disposal sites/facilities)
  - the dealer from whom the new appliance is purchased, who is required to collect them free of charge (“one-for-one” collection).
- 

## **Information on disposal in European Union countries**

The EU Directive on WEEE appliances has been implemented differently by each country. Therefore, if you want to dispose of this appliance, we recommend you contact your local authority or dealer for information on the correct disposal method.

---

# 3. Your Digital.ID™

- [SPEED-X™](#) Characteristics
  - [Digital.ID™](#) features
-

# SPEED-X™ Characteristics

SPEED-X™ is the first ever self-washing combi speed oven: the perfect combination of quality and speed.

## How SPEED-X™ works

With SPEED-X™ two types of cooking are possible:

**Traditional combination cooking** and convection with steam combine to guarantee flawless cooking.

**Hyper.Speed:** the revolutionary technology that combines cooking with microwaving. Thanks to HYPER.Speed mode you can choose to cook a single dish on a whole tray, or up to four different single portions with the help of MULTI.Time.

### Some examples?

- Whole sea bass on a bed of potatoes in 330 seconds
- Sorrentine-style stuffed gnocchi in 180 seconds
- Mix of sandwiches with ham, cheese, mushrooms and vegetables in 75 seconds

The SPEED-X™ cooking chamber has a capacity of 10 GN 2/3 trays with 35 mm | 1.38" pitch or 5 GN 2/3 trays with 70 mm | 2.75" pitch for combi mode and a position dedicated to the SPEED.Plate tray to perform up to 4 accelerated cooking processes at the same time in speed mode.

---

# SPEED-X™ News

## **Water filtering and automatic washing: nothing is missing.**

Cleaning speed ovens is no longer a problem. SPEED-X™ feature a ROTOR.Klean automatic washing system integrated with a 1L | 0.26 US Gal capacity DET&Rinse Ultra tank and RO.Care water filtering system to guarantee up to 1300L | 343.4 US Gal of filtered water. That's not all: thanks to the SENSE.Klean sensor, the oven is able to accurately detect the degree of dirt and to suggest the most suitable washing mode to avoid waste. It does everything!

## **Control panel**

The innovative [Digital.ID™](#) control panel has been completely redesigned to ensure an unparalleled usage experience. A fresh, simple and intuitive design that allows you to monitor and control your oven with the speed of a touch.

## **Door with push-to-close function**

The door with push-to-close function allows maximum speed in taking in and out of the oven. When the oven is closed, just push the door for instant closure. Greater freedom of movement, greater simplicity in actions.

## **316L Marine-grade stainless steel cooking chamber**

The cooking chamber of the SPEED-X™ ovens is made of 316L steel, the one ships are built of to withstand the aggression of sea waters. Combined with RO-Care, it allows to avoid water treatment with osmosis systems even in case of high levels of chlorides.

## **Perpendicular Microwaves**

Microwaves radiate from the upper part of the cooking chamber, perpendicular to the SPEED.Plate tray for speed cooking. Speed, effectiveness and uniformity.

## **Symmetrical reversing fans**

The high-flow fans distribute the air in a powerful and homogeneous way on each tray, from the first to the last. Uniformity and cooking speed at the highest levels.

## **High performance heating elements**

SPEED-X™ ovens use special high power intensity straight line resistances that produce heat quickly, minimizing temperature recovery times and optimizing air flows.

## **Lower drawer**

A space for the Det&Rinse™ detergent bottle and for the built-in RO.Care water filter. A compartment under the oven which contains everything you need for the daily care of your oven.

---

# Digital.ID™ Features

Digital.ID™ is the most advanced operating system ever installed on an oven. Fast and intuitive interface with hyper-connection functions powered by artificial intelligence.

## Digital.ID™ Hyperconnection

With Digital.ID™ you can access the interface of your ovens on all your devices, wherever you want, whenever you want, without the need for high-speed internet connection. Import any customization and recipe on all your ovens and devices via the [Digital.ID™ app](#).

---

# Digital.ID™ Account

Create your Digital.ID™ and log in to your SPEED-X™ oven connected to the internet: memorize your cooking programs, the configuration of your home page and all the customizations of your oven directly on the cloud. The account stays in constant sync with the most recent changes, also allowing you to edit them directly from your smartphone. You can log in to your account from any SPEED-X™ oven connected to the internet and immediately have access to your settings.

---

# Digital.ID™ Widgets

With the new widgets you work with the most intuitive interface ever seen on an oven. Customize the home screen according to your needs or choose a preset layout designed for your business to have your favourite features always in the foreground.

---

# DIGITAL.Training

With the purchase of a Digital.ID™ oven you can receive free Premium base training that will teach you all the tricks to take 100% advantage of your oven from the very first days after installation.

Our Active Marketing Chefs are available remotely to show you everything you need, from basic functions to the most advanced technologies.

---

# COOKING.Concierge

Do you need advice? Do you want to optimize the use of your oven? Do you want to perfect a cooking process? Do you need instructions for a recipe?

If you have activated the Premium\* digital services you can book a Premium call with our Corporate Chefs directly from your oven and talk to them thanks to the internal microphone to receive up to 30 minutes a month of live advice. With the new Badge function you will be able to carry out instructions during the call, while with the Remote Control function you can allow the chef to set your oven remotely.

---

## Live Technical Assistance

Do you need help? If you are a Premium\* customer you can call our technical team directly from your oven and speak to our operators via the internal microphone. Moreover, thanks to the built-in chat and camera function of the [Digital.ID™ app](#) you can send messages and images to help the team diagnose and resolve your doubts more quickly and accurately.

---

# 4. Basic concepts

- [Symbols used in the manual](#)
  - [Digital.ID™ Control Panel](#)
  - [Using gestures](#)
  - [UNOX technologies](#)
-

# Symbols used in the manual

Symbol

Gesture

---



**Tap**

Tap the screen gently with one finger.

---



**Tap and hold down**

Tap on the screen and hold down until the desired action starts

---



**Drag right**

Drag your finger from left to right.

---



**Drag left**

Drag your finger from right to left.

---



**Drag up**

Drag your finger from the right upwards.

---



**Drag down**

Drag your finger from the right to downwards.

---



# Digital.ID™ Panel

## Home Page Navigation

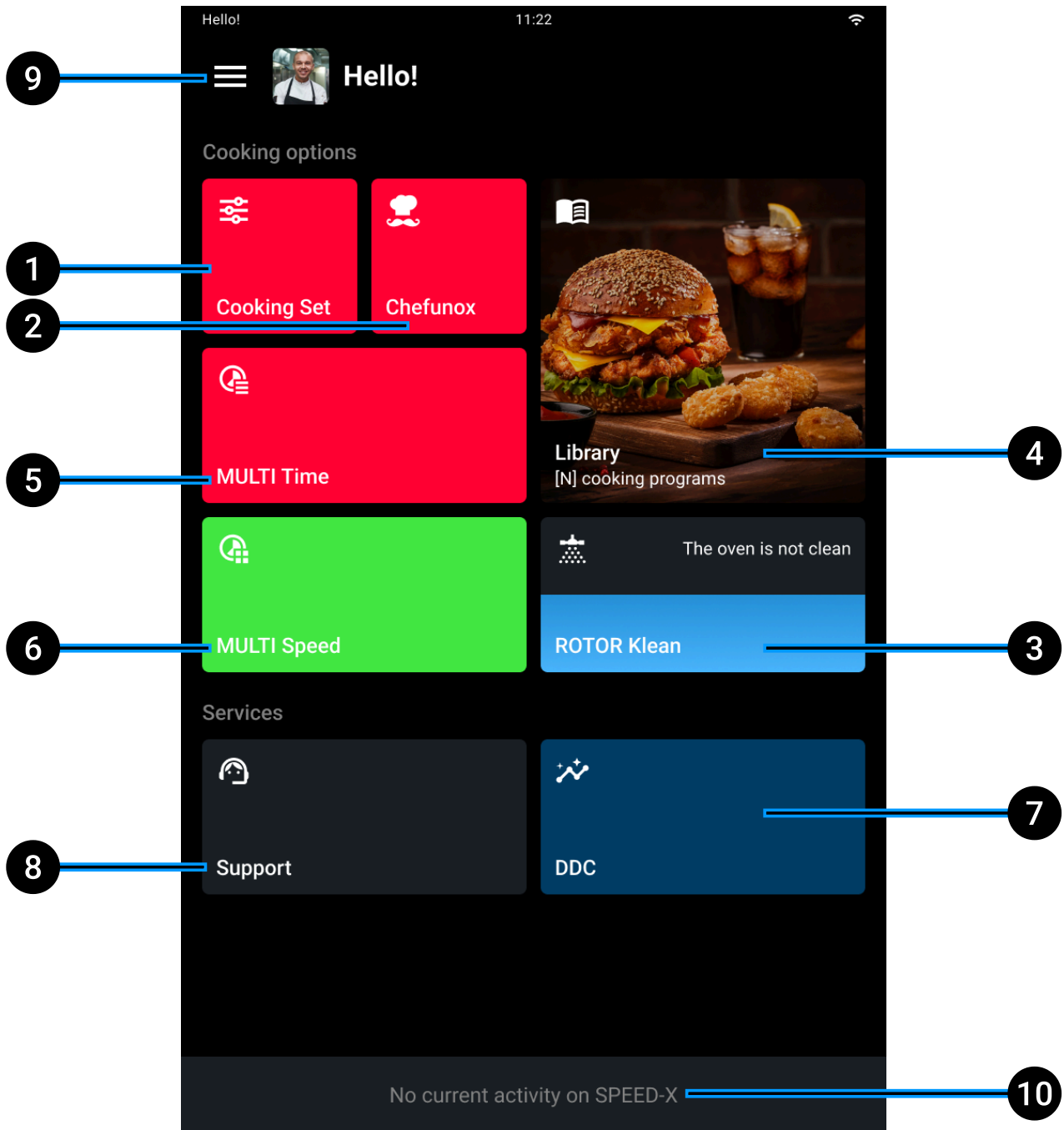

- 1 **[Cooking Set](#)**: thanks to the new PRESET function you can access a library of preset, customisable parameters, that will suggest the ranges of temperature, humidity and ventilation required for any type of cooking: frying, grilling, browning and much more;
- 2 **[Chefunox](#)**: the oven autonomously sets all the cooking parameters; you just have to choose the type of cooking, the food to be cooked and the degree of cooking you want and start cooking;
- 3 **[Washes](#)**: thanks to the Rotor.Klean technology, SPEED-X™ is the first self-washing speed oven. A smart oven that is able to accurately detect the degree of dirt and suggest the most suitable washing mode to achieve zero waste;
- 4 **[Library](#)**;
- 5 **[MULTI.Time](#)**: with MULTI.Time you can manage up to 10 cooking cycles at the same time, each one monitored by a specific timer that alerts you when it is time to take it out of the oven. The slider cursor lets you set all the timers quickly and accurately;
- 6 **[MULTI.Speed](#)**: speed cooking mode that lets you simulate the arrangement of the food on the SPEED.Plate on the control panel. You can manage up to 4 speed cooking cycles at the same time and cook any type of food, from precooked dishes to sandwiches, vegetables to meat;
- 7 **[DDC \(Data Driven Cooking\)](#)**: this application, thanks to a fully redesigned graphic interface, is the most advanced IoT infrastructure on the market. The new update provides feedback and statistics on the use of the oven much more quickly. What's more, thanks to the new Kitchen Scheduler you can optimise planning your cooking and minimise time and energy wasted;

- 8 **Support:** if you've activated Premium digital services you can book a Premium call with the UNOX Corporate Chefs right from the oven and talk to them using the microphone inside to get advice in real time. With the new Badge function you will be able to follow instructions during the call, while with the Remote Control function you can allow the chef to set your oven remotely;
  - 9 **Profile and customisation:** thanks to the new widgets you can customise the Home Page by dragging the icons into the preferred position based on each chef's needs or, alternatively, choose a preset layout;
  - 10 **Activities in progress:** display of activities in progress.
-

# Control panel

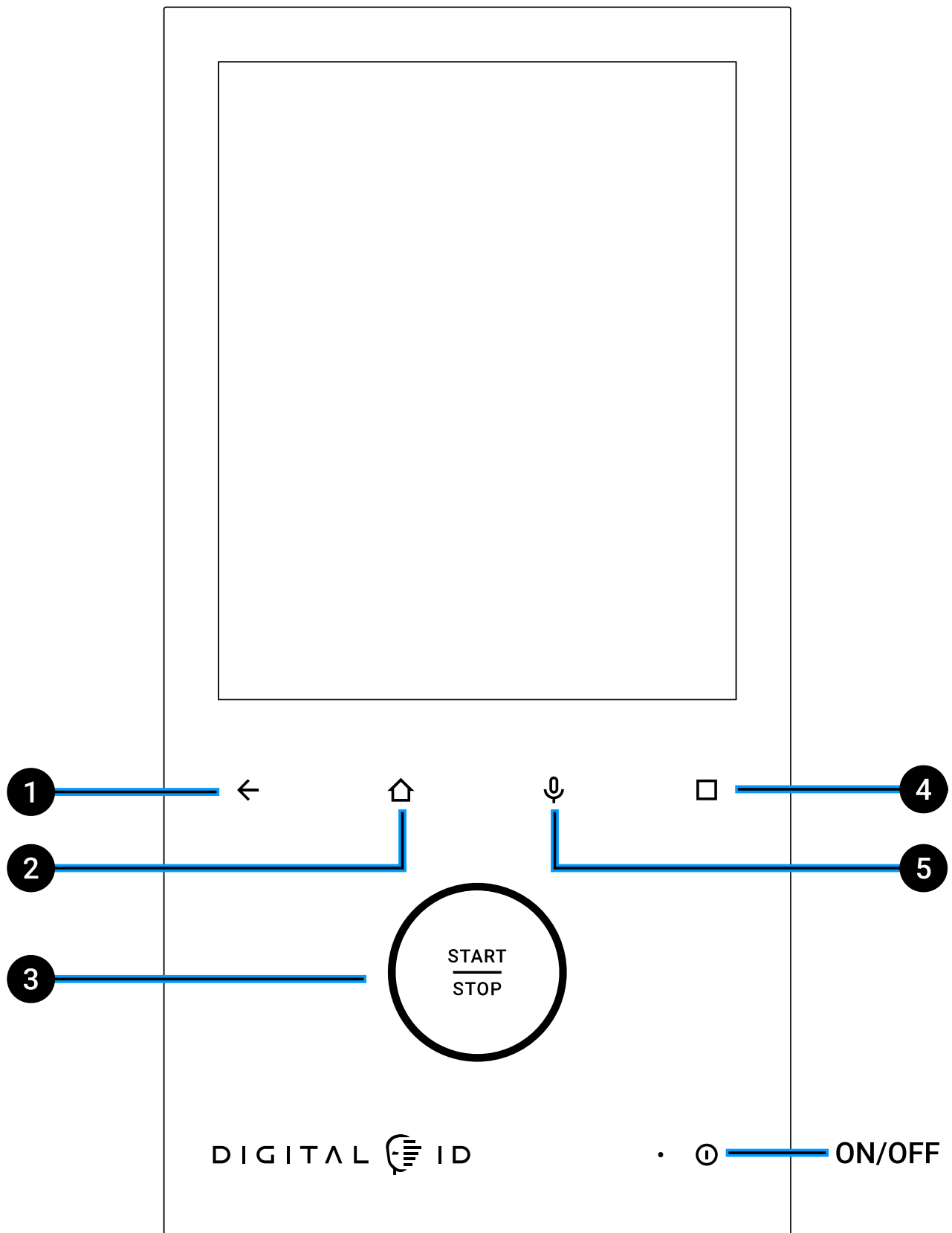

- 1 **Back arrow:** go back to the previous page;
- 2 **Home button:** go to the [Home Page](#);
- 3 **Start/stop button:** start or stop an activity in progress;
- 4 **Custom button:** customise the action of the button through the relevant page on [system settings](#);
- 5 **Voice button:** activate the internal microphone for voice commands and to communicate with UNOX operators and Chefs during calls.



Be careful, the ON/OFF button turns the control panel on and off but does not disconnect the oven from the power supply. It is still live until its plug is taken out.

---

## Lock screen with door open

For safety reasons and to achieve excellent performance and results, cooking must be carried out with the door closed.

If you open the door during cooking, the oven heating elements are deactivated, the fan stops and a notification tells you that the display is temporarily locked.

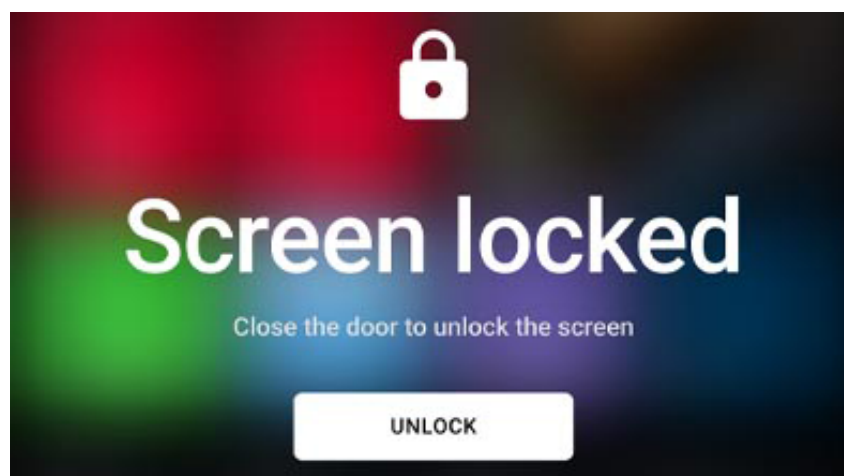

---

# Touch commands on capacitive display

Your oven's control panel uses **Touch control technology** which lets you browse through the Digital.ID™ operating system simply by tapping the icons with clean, dry fingers (don't use utensils).

All the apps are managed with **cards**, each of which allows full control of the contents of the app.

---

## Navigating accounts and profiles on the side menu

If you create a personal profile, you can store your cooking programs, decide the configuration of your Home Page and all the customisations of your oven.

- Tap the menu 
- tap + NEW PROFILE, write your name and SAVE.



My SPEED-X

Profiles



Hello!



Andrew



Profile 5



Add new profile



Manage accounts



Settings



programs

The oven is not clean

an

-X

Return to the Home Page, tap and hold down anywhere.  
In the card that appears you can:

- **drag** widgets into the position you prefer;
- **add** widgets by pressing the key at the bottom + ADD WIDGET;
- **remove** the current widgets by tapping the REMOVE key 

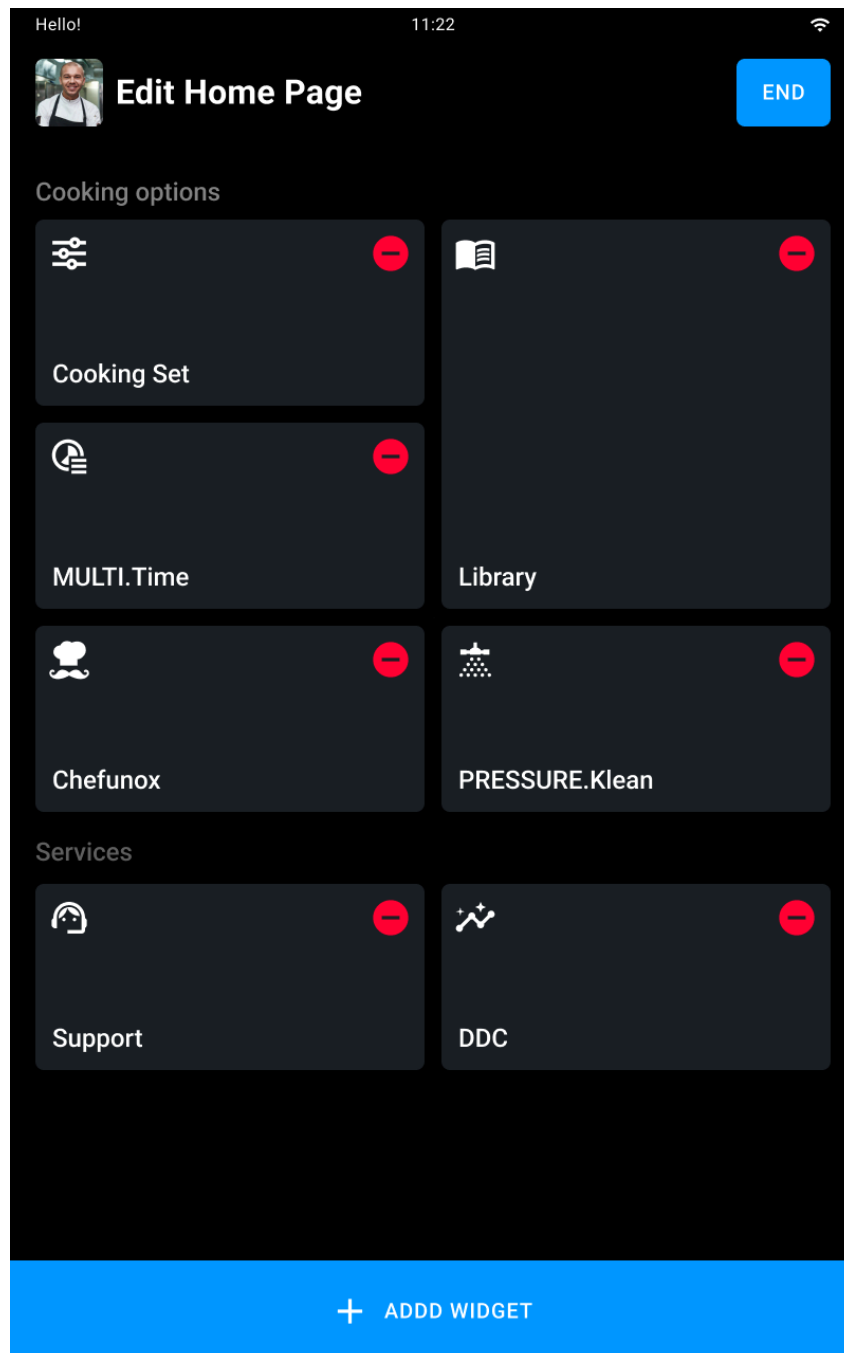

When customisation is completed, tap the SAVE key to exit and confirm what you have set.



---

# Access settings

If you want to make personal settings:

- tap the menu 
- tap SETTINGS 

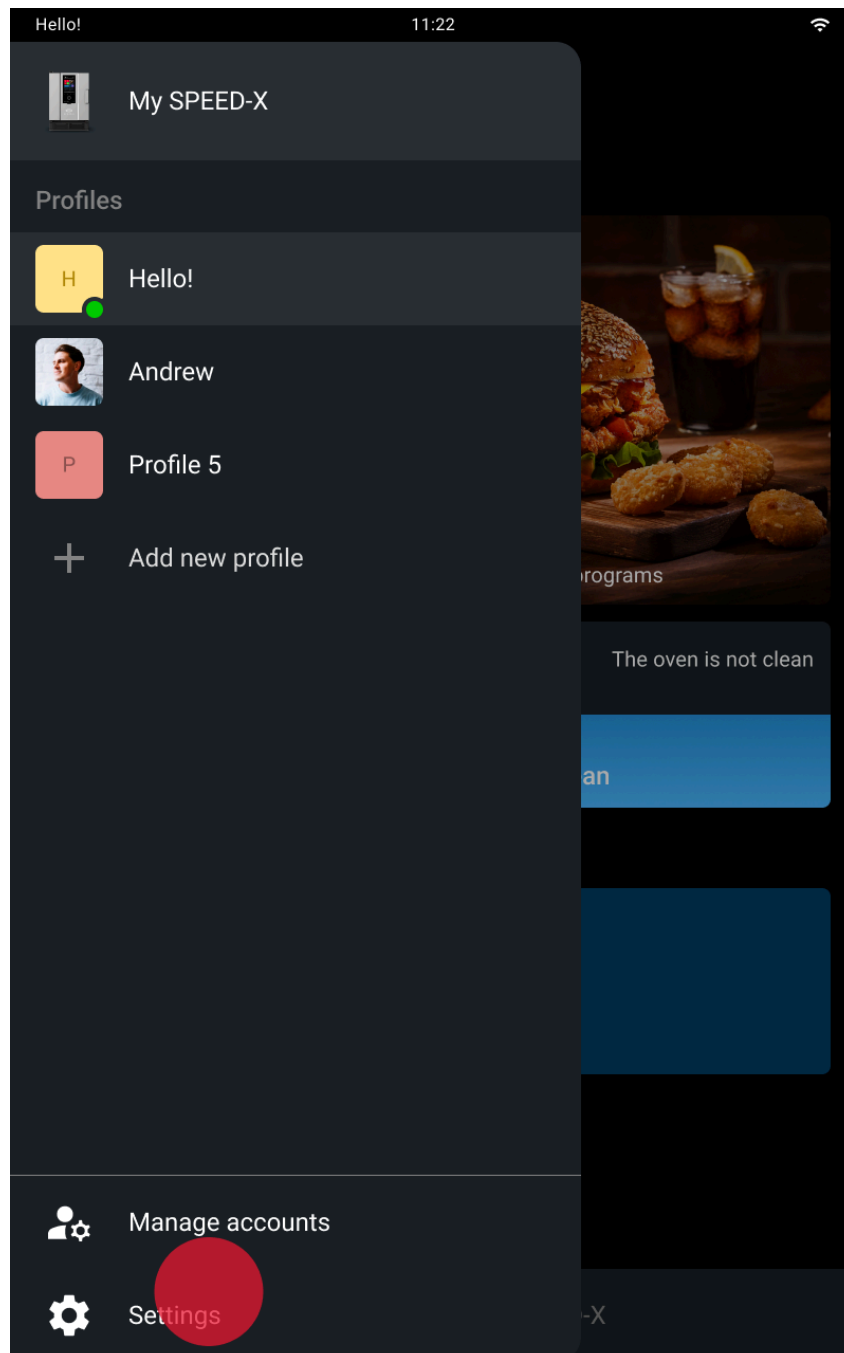

# Using gestures

## Slider menu

The **slider menus** let you see and manage several topics in a single card, permitting an overall view.

To display them, drag the card right or left.

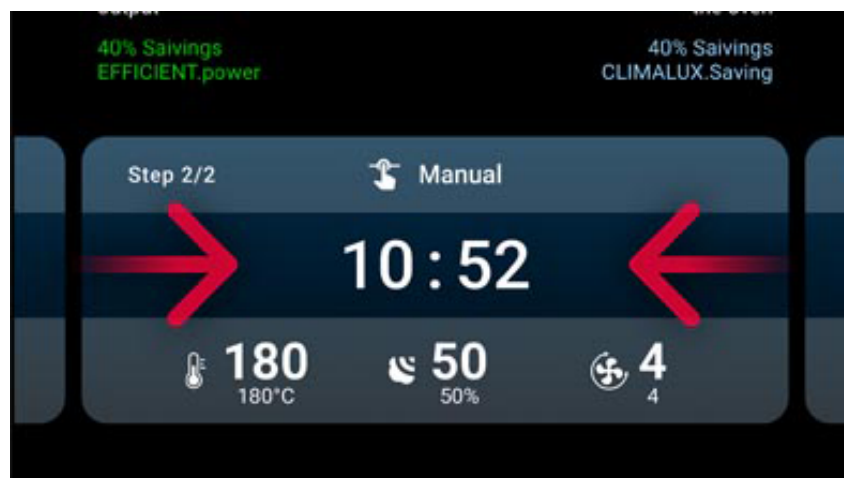

# Setting a time value

To set a **time value** drag the number up or down.

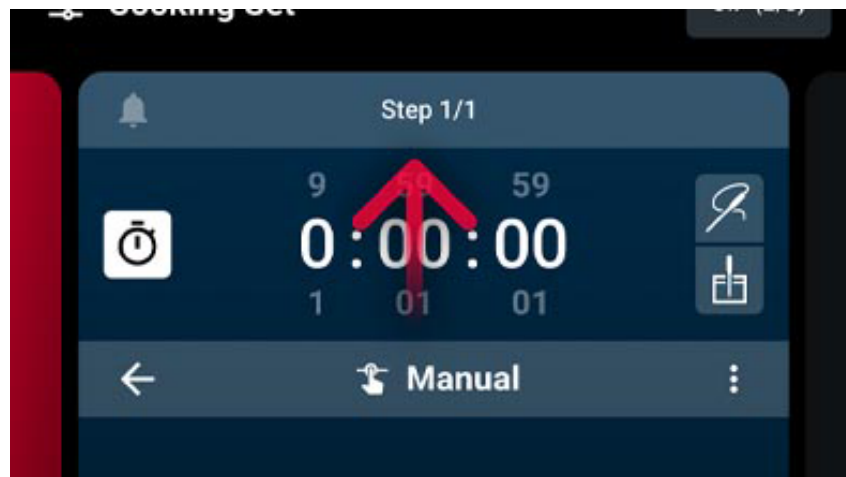

---

# Setting a slider value

To set a **slider value**, drag the cursor right to increase it or left to reduce it.

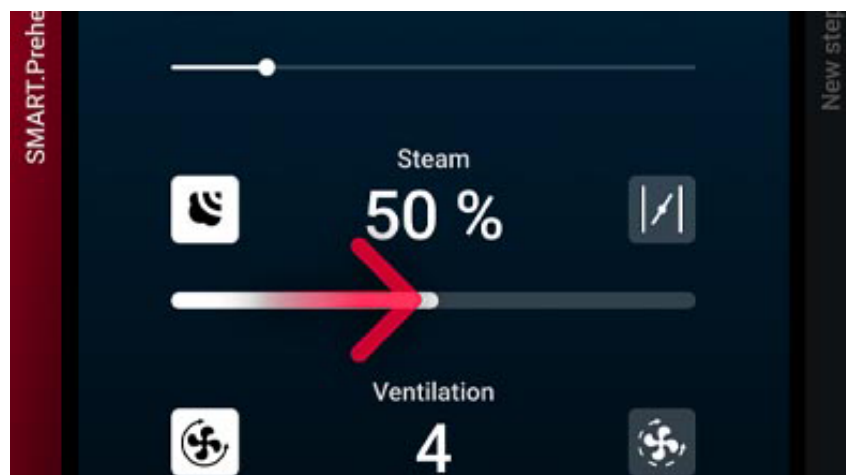

# UNOX technologies

## **Individual.CHEFUNOX**

Smart function that prompts the user for feedback on cooking results. Use machine learning technology to process the feedback received, learn the user's preferences and improve the preset cooking programs

## **Individual SENSE.Klean**

Smart function to request and analyse feedback from the operator on the washes performed, to recommend the best wash to start according to how dirty the oven is

## **SMART.Preheating**

Automatically set the temperature and preheating duration according to previous modes

## **SENSE.Klean**

Estimate how dirty the oven is and suggest the most suitable automatic wash

## **SMART.Energy**

Automatic energy saving function that cuts water, electricity or gas consumption in cooking programs longer than one hour. Recognise when there is no food in the cavity and activate standby mode, reducing the temperature and saving energy. Analyse oven use to provide useful energy saving tips (e.g. signals if the door is left open for a long time)

## **HEY.Unox**

Voice recognition technology for interacting with the oven, giving commands and receiving audio-visual feedback on the panel

# Unox Intelligent Performance (UIP)

**UIP (Unox Intelligence Performance) technologies** allow the oven to constantly monitor each preheating and cooking process.

In this way the software that manages the oven independently modifies the conditions to ensure cooking results that are always perfect!

Below you will find the UIP technology available on your oven:

## **ADAPTIVE.Cooking**

Automatically adjust cooking parameters according to the load to guarantee repeatable results

# Unox Intensive Cooking (UIC)

## **DRY.Maxi™**

Rapidly remove large quantities of humidity from the cooking cavity

## **STEAM.Maxi™**

Rapidly produce a large quantity of steam in the cooking cavity

## **AIR.Maxi™**

Automatically invert continuous and pulse fan mode

## **HYPER.Speed**

It combines microwave, steam and convection functions to reduce cooking time.

---

# 5. Basic concepts for cooking

- [Preparing and starting a cooking cycle](#)
  - [Cooking cycle in progress](#)
  - [Cooking summary](#)
  - [Actions after cooking](#)
-

# Preparing and starting a cooking cycle

Cooking can be performed as follows:

- in [manual mode](#) (Cooking Set);
- as multicooking ([Multi.Time](#) - [Multi.Speed](#));
- with previously [saved recipes](#) (Library);
- with [recipes preset by UNOX](#) (Chefunox).

To start all cooking cycles, irrespective of type, tap the START/STOP button 

---

## Starting a manual Cooking Set cycle

To start or create a [Cooking Set manual cooking cycle](#), you must set the cooking time and select either:

- a **preset program with parameters already filled in** based on the most popular types of cooking;
  - a **Manual** preset program, fully customisable, that sets no limits to parameters.
-

# Starting a saved cooking cycle from the Library

The recipes you have previously saved are collected in the [Library](#) app: to start them, tap the recipe you want and tap the  button

---

# Starting a cooking cycle from Chefunox - Speedunox

The [Chefunox](#) - [Speedunox](#) apps contain the recipes created and tested by the UNOX chefs to help you achieve excellent cooking results.

If necessary, during cooking you can **edit** the recipe; in this event the variations are valid only for the cooking cycle in progress.

At the end of the cooking cycle you can **save** the edited recipe under another name (the UNOX recipes cannot be changed or deleted). Your edited recipe will be stored in the [Library](#) app.

---

# Starting an indefinite MULTI.Time or MULTI.Speed cooking cycle

The [MULTI.Time](#) - [MULTI.Speed](#) apps allow you to cook products that require different cooking times at the same time, under equal conditions (temperature, humidity, fan speed and/or microwaves).

If you use these apps, the oven maintains the cavity conditions you have set for an indefinite period. You can also set additional cooking timers that will alert you when the relevant tray is ready.

---

# Cooking cycle in progress

Editing a Cooking Set cooking cycle that's in progress

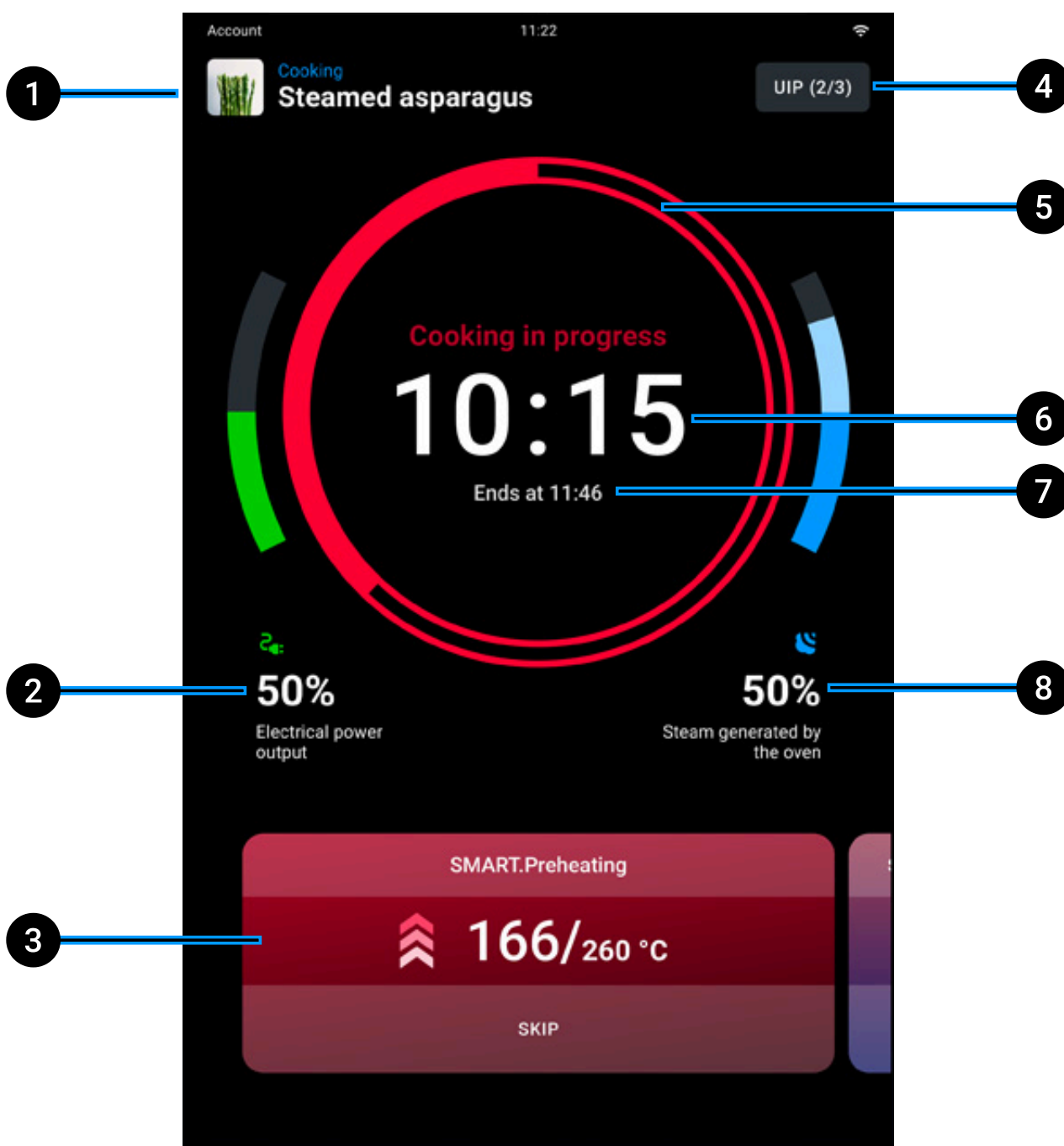

- 1 **name** of the recipe in progress (“Manual program” = recipe not saved)
  - 2 **monitoring** the power output;
  - 3 **parameters set** in progress: tap the card to change the cooking parameters or add other cooking steps. The changes are valid only for the cooking cycles in progress (the UNOX preset programs cannot be permanently edited); if you drag the card to left or right the preheating card and card for subsequent steps are displayed respectively (if any);
  - 4 **UIP**: you can edit activation of the [Unox Intelligence Performance](#) technology (not recommended);
  - 5 **cooking cycle end bar**: the colour of the bar gives an intuitive indication of the end of the cooking cycle:
    - if > 15 seconds the time bar is **red**
    - if < 15 seconds the time bar is **yellow**
    - if < 5 seconds the time bar is **green**
  - 6 **total cooking time**;
  - 7 **end of cooking** time;
  - 8 **monitoring** steam generated.
-

# Editing a MULTI.Time cooking cycle that's in progress



- 1 **timer not expired**: end of cooking > 15 seconds;
  - 2 **timer not expired**: end of cooking < 15 seconds;
  - 3 **timer expired**: end of cooking < 5 seconds;
  - 4 **cancel** the timer;
  - 5 **confirm** the expired timer and go back to the settings;
  - 6 enable **variations** to the climate set in progress in the absence of active timers, see how [to edit climate set](#) here.
  - 7 **set a new timer**, by entering a duration (hours : minutes) or adding an already existing program.
-

# Modifying a MULTI.Speed cooking cycle that's in progress

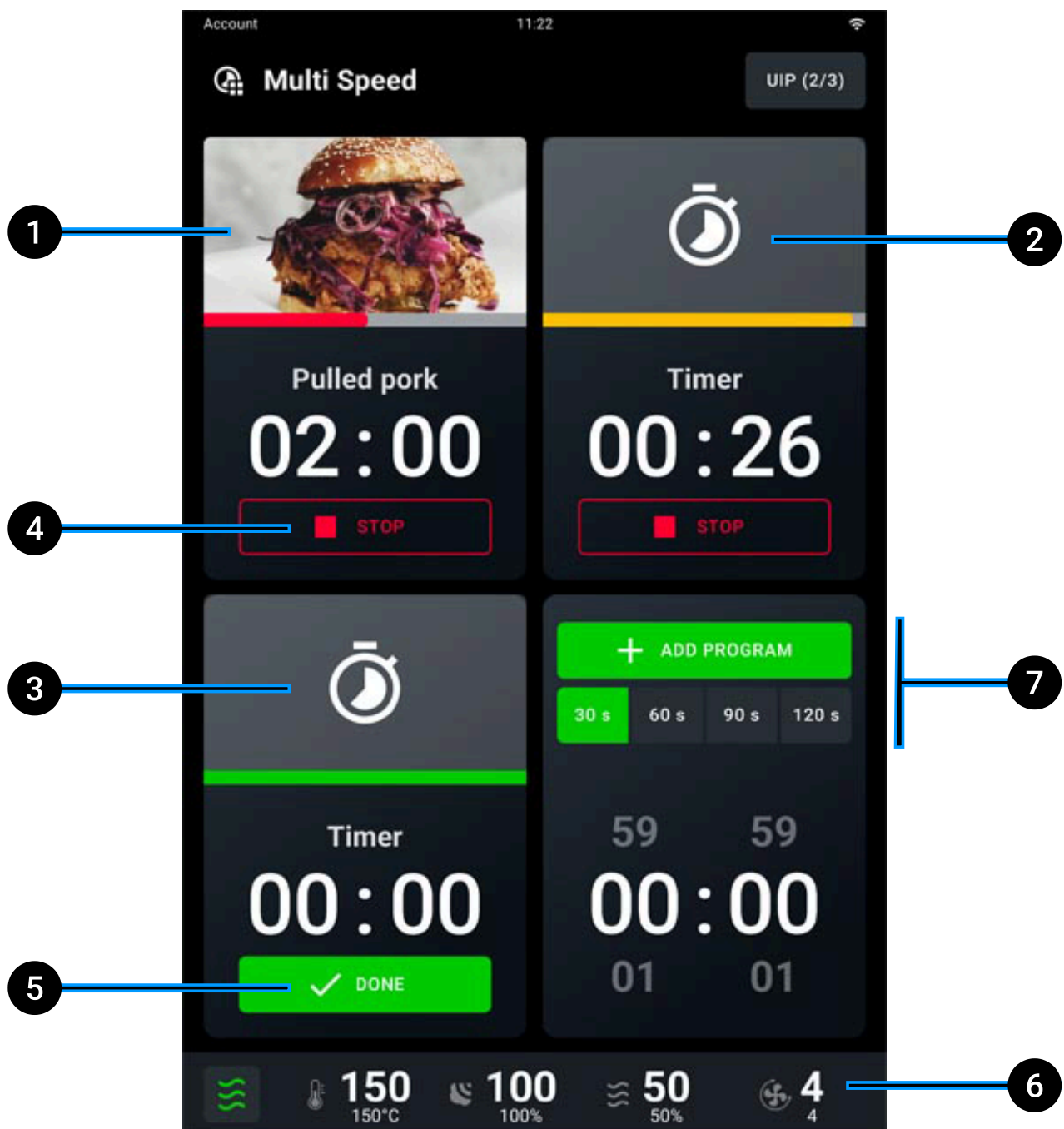

- 1 **timer not expired**: end of cooking > 15 seconds;
  - 2 **timer not expired**: end of cooking < 15 seconds;
  - 3 **timer expired: end of cooking** < 5 seconds;
  - 4 **cancel** the timer;
  - 5 **confirm** the expired timer and go back to the settings;
  - 6 enable **variations** to the climate set in progress in the absence of active timers, see how [to edit climate set](#) here.
  - 7 **set a new timer**, by entering a duration (hours : minutes) or adding an already existing program.
- 

# Ending a cooking cycle in progress

Cooking cycles end when the anticipated time elapses or when the core temperature set is reached (if applicable).

If you tap and hold down the start/stop  button the cooking cycle in progress is interrupted.

---

# Cooking summary

At the end of the cooking cycle you can stop the buzzer by tapping the STOP BUZZER button. If you open and close the door you can see the cooking summary screen.

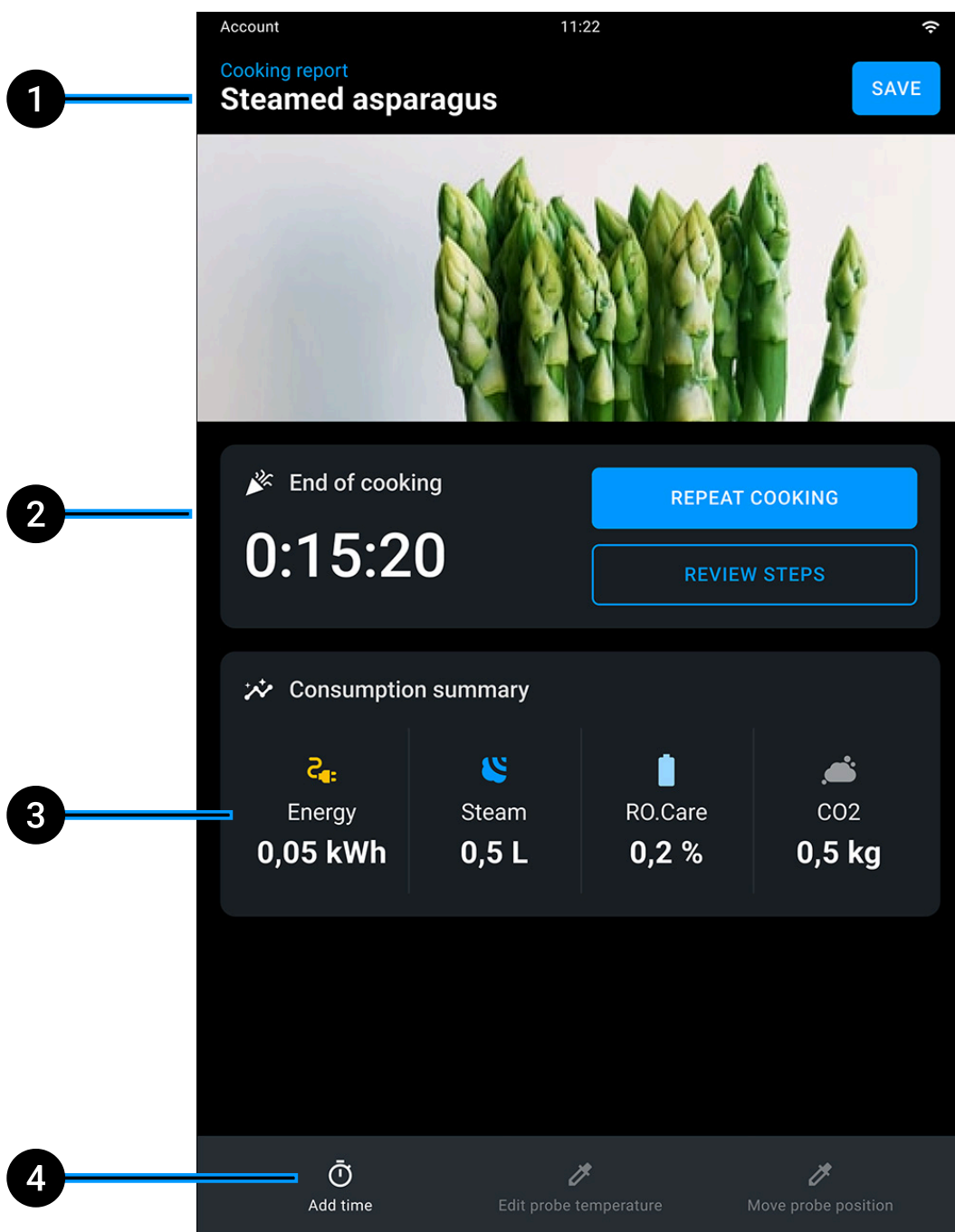

- 1 **name** of the recipe in progress;
  - 2 **duration** of cooking cycle just ended;
  - 3 **consumption summary** (electricity, steam, RO.Care, CO<sub>2</sub>);
  - 4 **add time** by keeping the parameters for the last step carried out or change the temperature of the core probe (if there is one).
-

# Actions after cooking

At the end of the cooking cycle a card appears summarising consumption and possible actions after cooking.

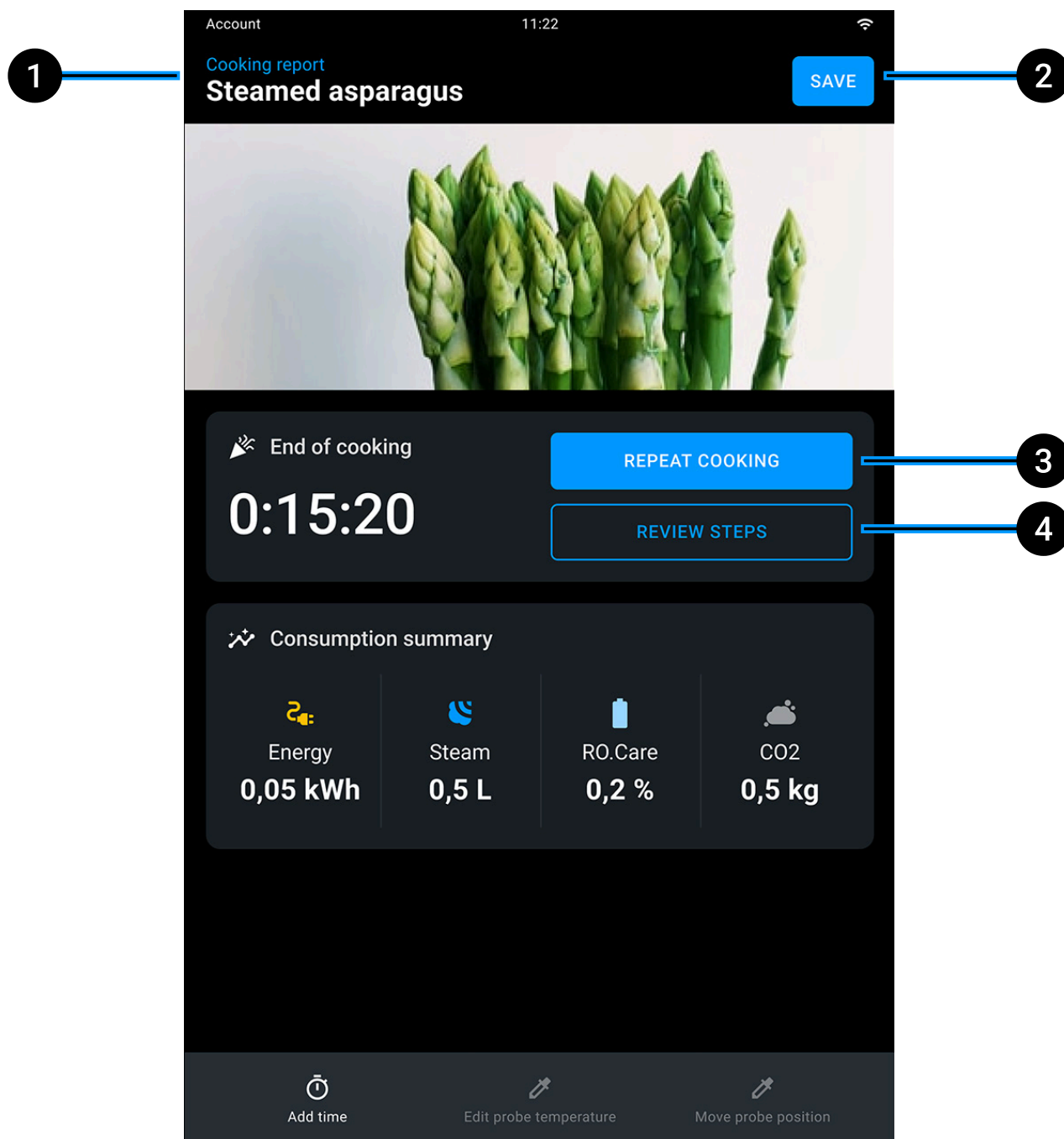

- 1 **name** of the recipe in progress;
  - 2 **save** the cooking cycle just ended; see how to save a cooking cycle [here](#);
  - 3 **repeat** the cooking cycle just ended with the same cooking parameters that can be changed as you require;
  - 4 **repeat** the last cooking step.
-

# 6. Basic concepts for water treatment and washes

- [Safety precautions](#)
  - [Starting a wash](#)
  - [Automatic cleaning with detergent](#)
  - [Manual precleaning](#)
  - [Descaling cycle using D&Cal Spray](#)
  - [Cleaning in progress](#)
  - [Wash summary](#)
  - [Scheduling a wash](#)
  - [Refilling Det&Rinse™ Ultra](#)
  - [Replacing the RO.Care filter](#)
-

# Safety precautions

Carefully read the product safety data sheet before handling and using the detergent. NEVER touch the detergent with bare hands. The detergent must not come into contact with the skin, eyes or mucous membranes. In the event of contact with the detergent, refer to the safety data sheet.

Do not insert ANYTHING inside the oven during the washing cycle, otherwise the washing is ineffective.

Do NOT open the oven door during a wash cycle as this could cause injury to eyes, mucous membranes and skin because of contact with the cleaning chemicals used. These chemicals are sprayed by the rotor in the cavity and moved by strong air currents.

Do NOT allow children to clean the appliance, especially when unsupervised by an adult.

Do NOT tamper with the detergent tank, its connections to the oven and the internal and external water circuit for any reason as this could cause a risk of injury or death.

Periodically check for rust stains inside the oven cavity: if any are found, contact a service centre urgently because the water is probably damaging the oven; prompt action will extend the lifespan of the equipment.

---

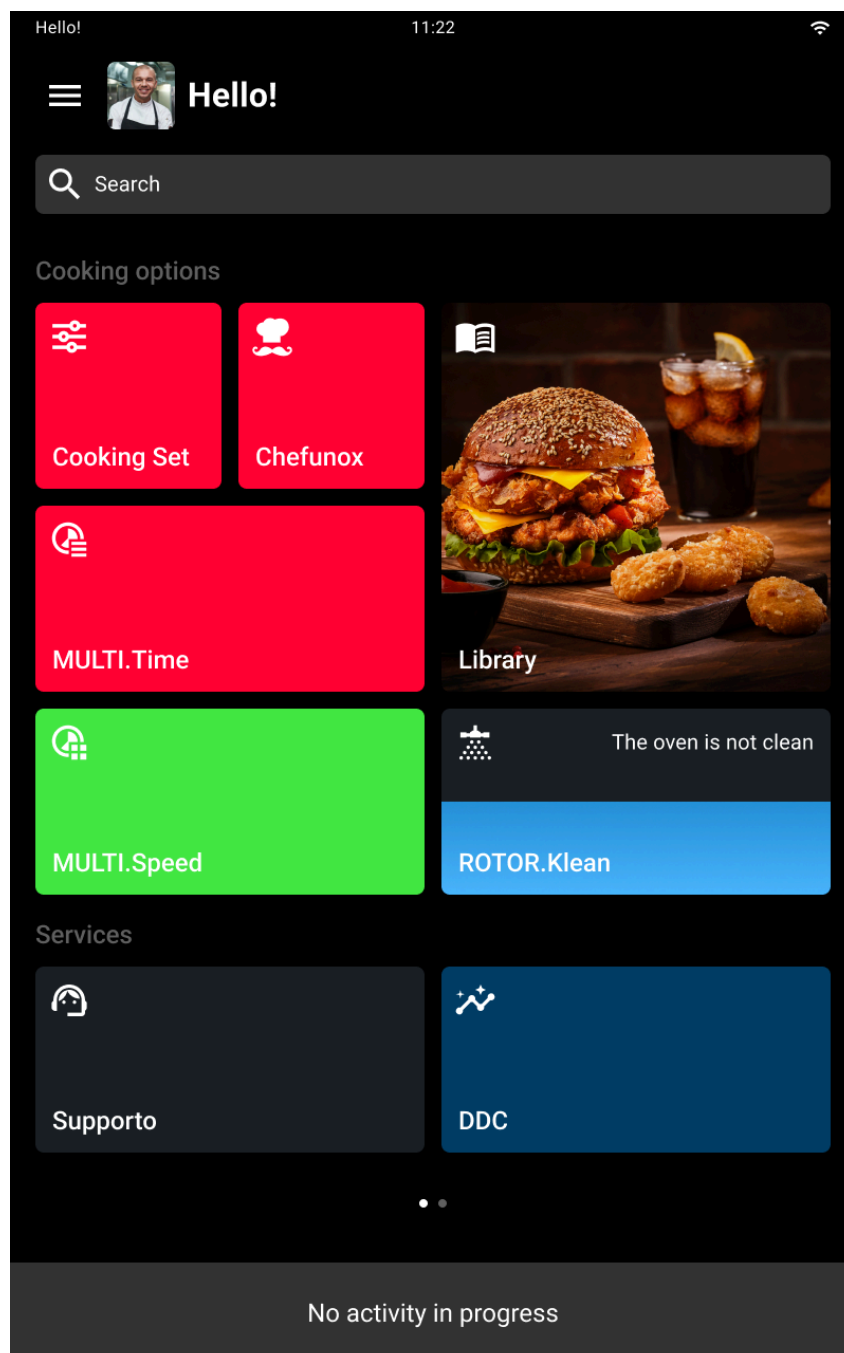

# Starting a wash

The ovens are fitted with the ROTOR.Klean automatic washing system: to start a program to wash the oven cavity tap the WASHING BUTTON.

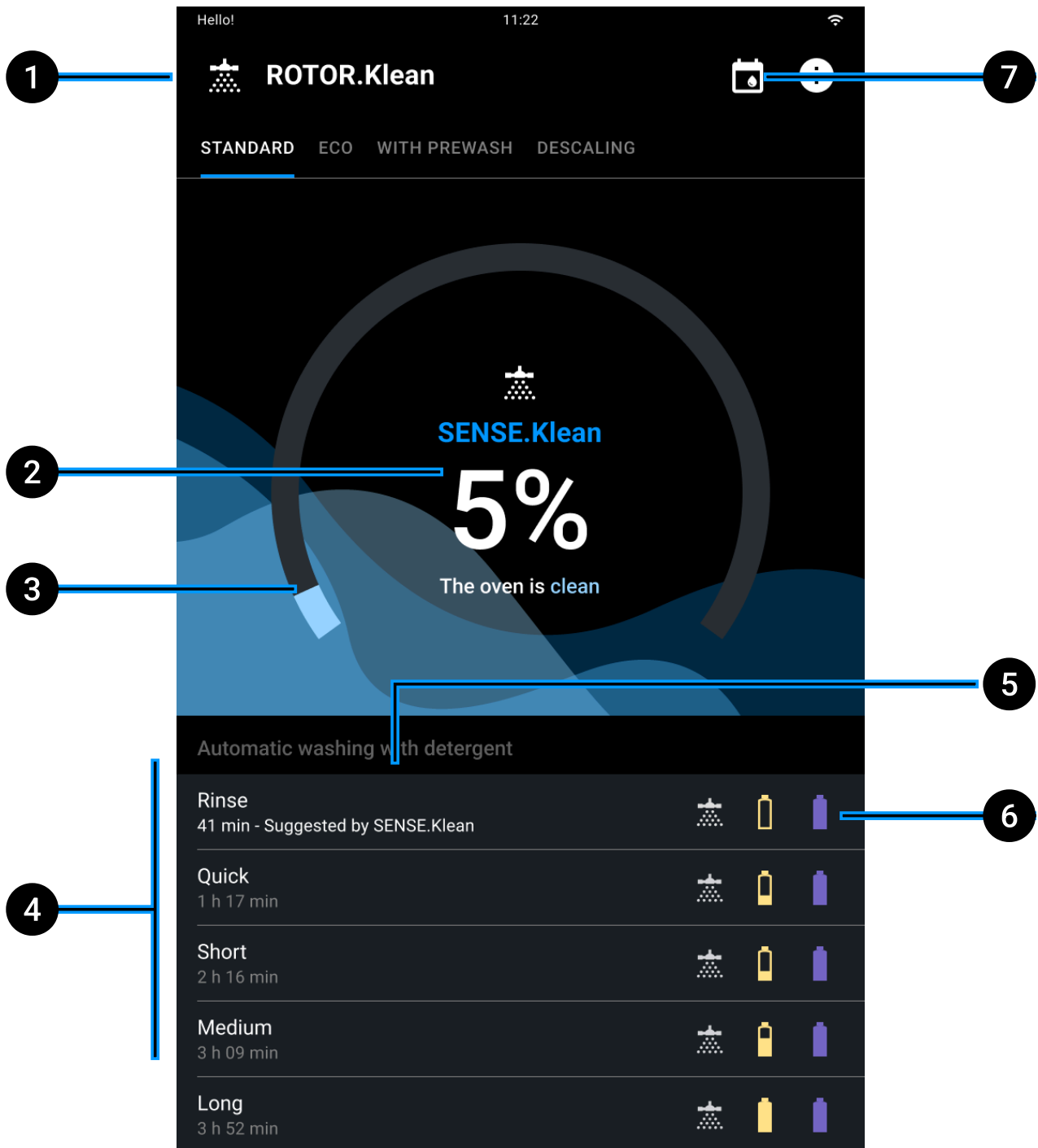

# Main page display and explanation



- 1 **program** name;
- 2 **percentage of dirtiness** of the oven;
- 3 **progress bar** of current wash;
- 4 **washes available**;
- 5 **recommended wash**;
- 6 **presence** or not of [Det&Rinse](#)  and/or [RO.Care](#)  during wash.
- 7 Scheduling washes

# Automatic cleaning with detergent

Tap the name of the wash that you think best suited to the degree of dirtiness of the oven cavity:

- RINSE: rinse the oven cavity;
- QUICK: quick wash of oven cavity;
- SHORT: oven cavity only slightly dirty;
- MEDIUM: oven cavity moderately dirty;
- LONG: oven cavity very dirty.

Hello!

11:22













ROTOR.Klean



STANDARD ECO WITH PREWASH DESCALING

  
**SENSE.Klean**  
**5%**  
The oven is clean

Automatic washing with detergent

|   |   |   |   |
|---|---|---|---|
| <b>Rinse</b><br>41 min - Suggested by SENSE.Klean |  |  |  |
| <b>Quick</b><br>1 h 17 min                        |  |  |  |
| <b>Short</b><br>2 h 16 min                        |  |  |  |
| <b>Medium</b><br>3 h 09 min                       |  |  |  |
| <b>Long</b><br>3 h 52 min                         |  |  |  |

# Automatic ECO cleaning with detergent

Tap the name of the wash that you think best suited to the degree of dirtiness of the oven cavity:

- SHORT: oven cavity only slightly dirty;
- MEDIUM: oven cavity moderately dirty;
- LONG: oven cavity very dirty.

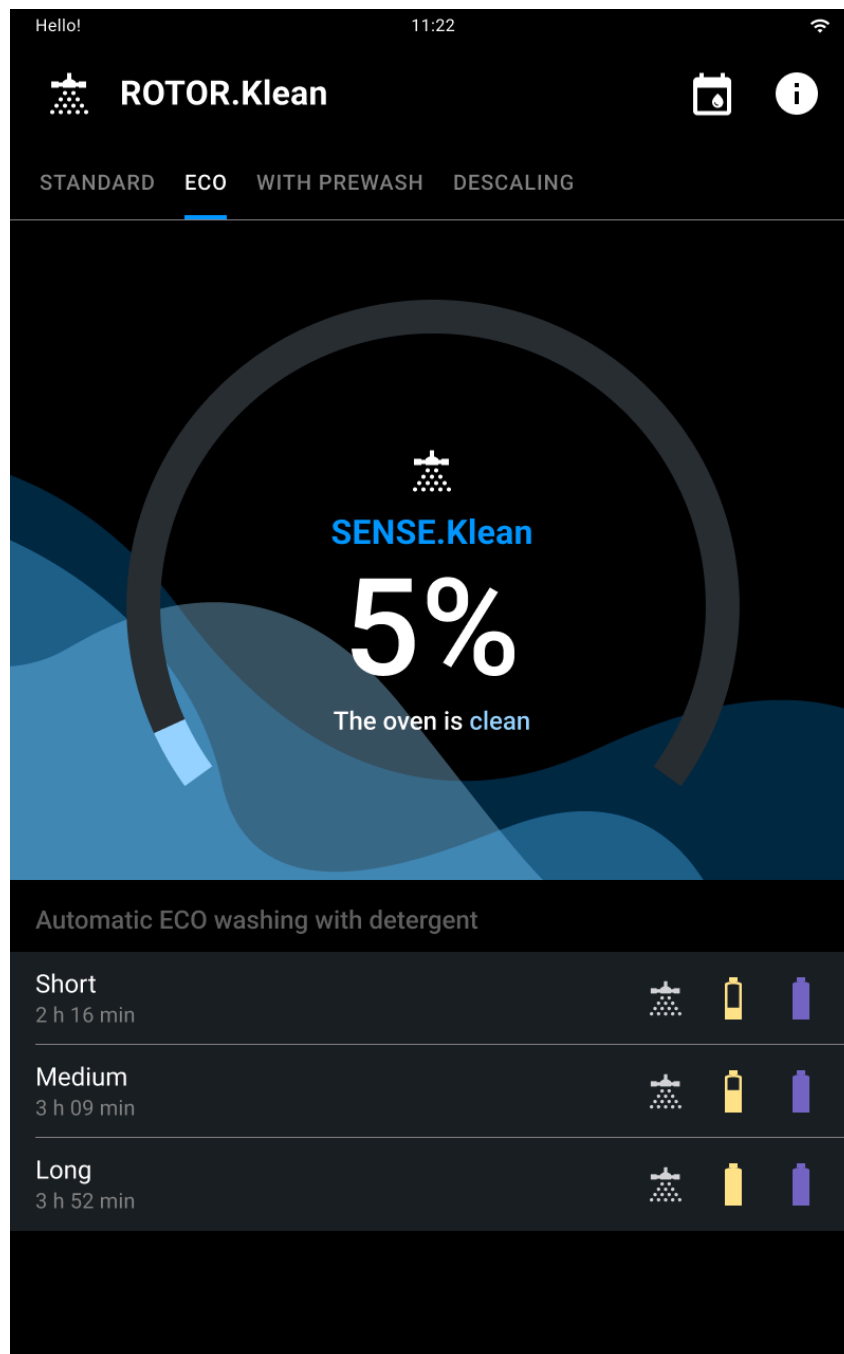

---

# Manual precleaning

Tap the name of the wash that you think best suited to the degree of dirtiness of the oven cavity. Then follow the procedure shown on screen.

- Short

- Medium
- Long

⚠ The door must stay open when the procedure requires it.

Do not clean using products containing flammable components.

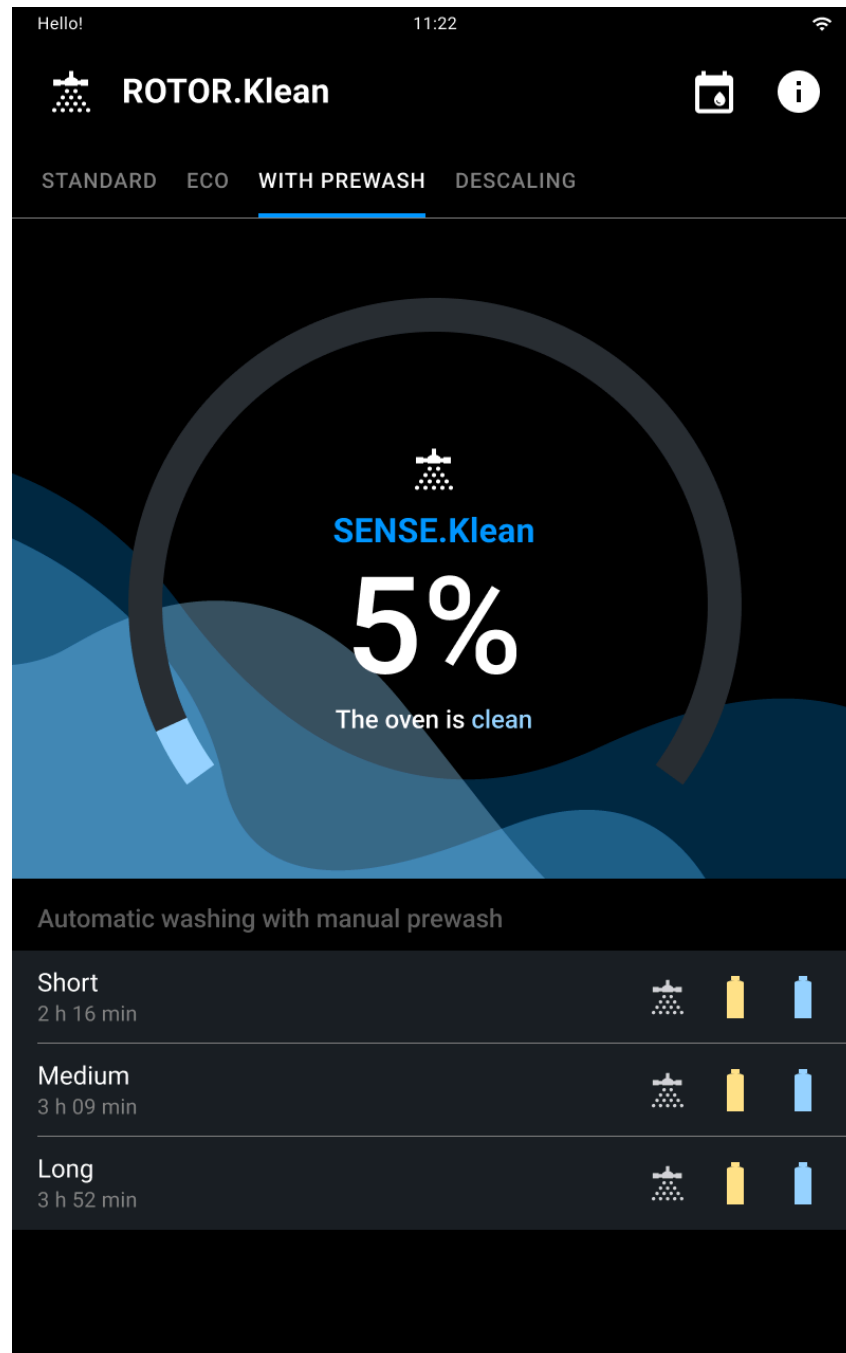

# Descaling cycle using D&CAI Spray

Select the descaling cycle based on the amount of scale in the oven cavity.

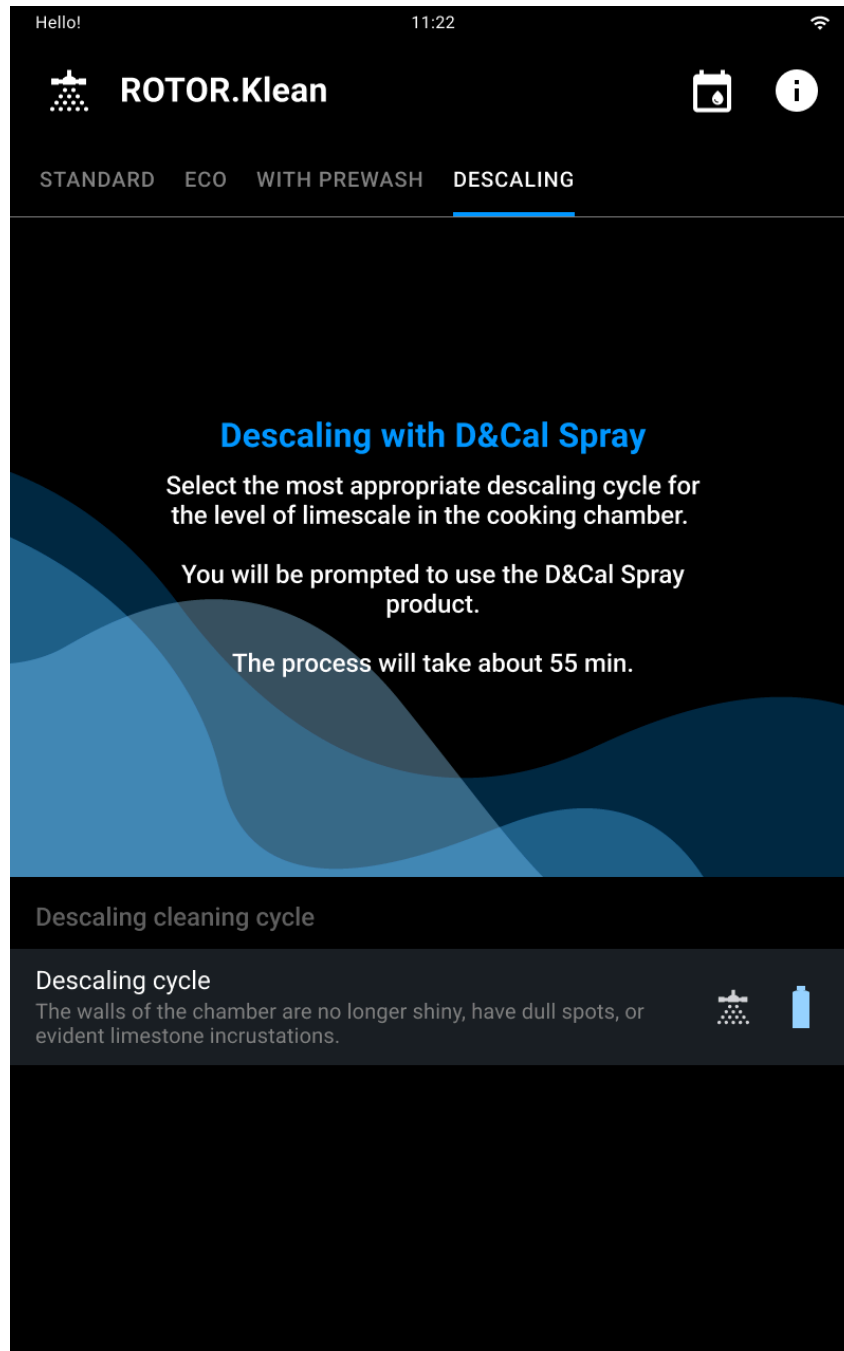

---

# Cleaning in progress

Hello!

11:22



1



Automatic washing

Long



Drain heating in progress

09:18

Ends at 11:46

3

4

2



**DO NOT OPEN THE DOOR**

Hazardous liquids are used in the chamber

- 1 **name** of wash in progress;
  - 2 **important warning** NOT to open the door while a wash is in progress;
  - 3 total wash **time**;
  - 4 **end of wash** time.
-

# Wash summary

At the end of the wash a summary card will appear and a buzzer will sound that you can stop by tapping the STOP BUZZER button.

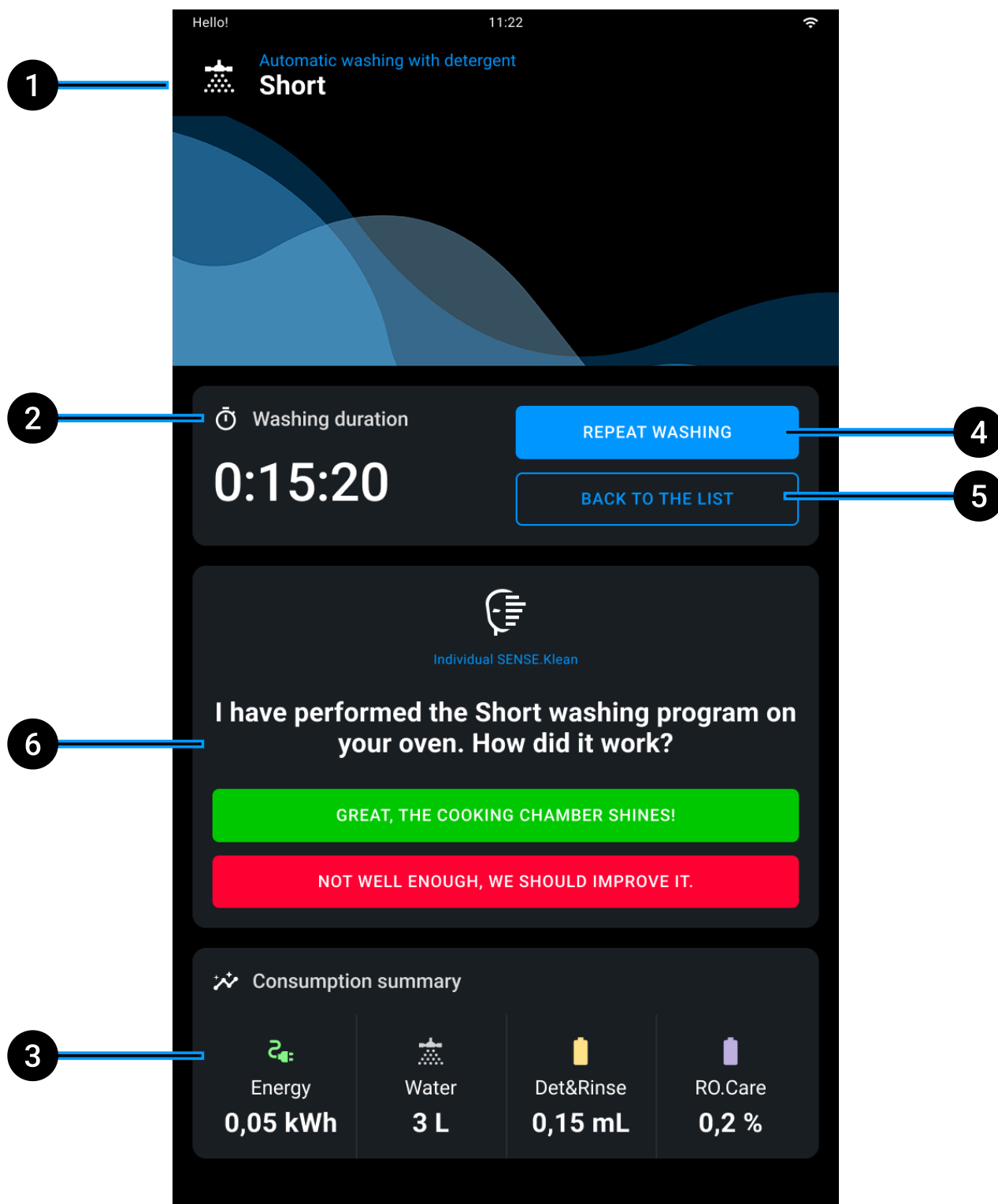

- 1 **name** of wash carried out;
  - 2 **duration** of wash just ended;
  - 3 consumption **summary** of water, [Det&Rinse](#) and [Ro.Care](#);
  - 4 **repeat** the wash just ended;
  - 5 **go back** to the list of washes;
  - 6 **information** about the completed wash.
- 

# Scheduling a wash

## Creating a wash schedule

Tap the “Scheduling washes” icon on the main page to access the function.

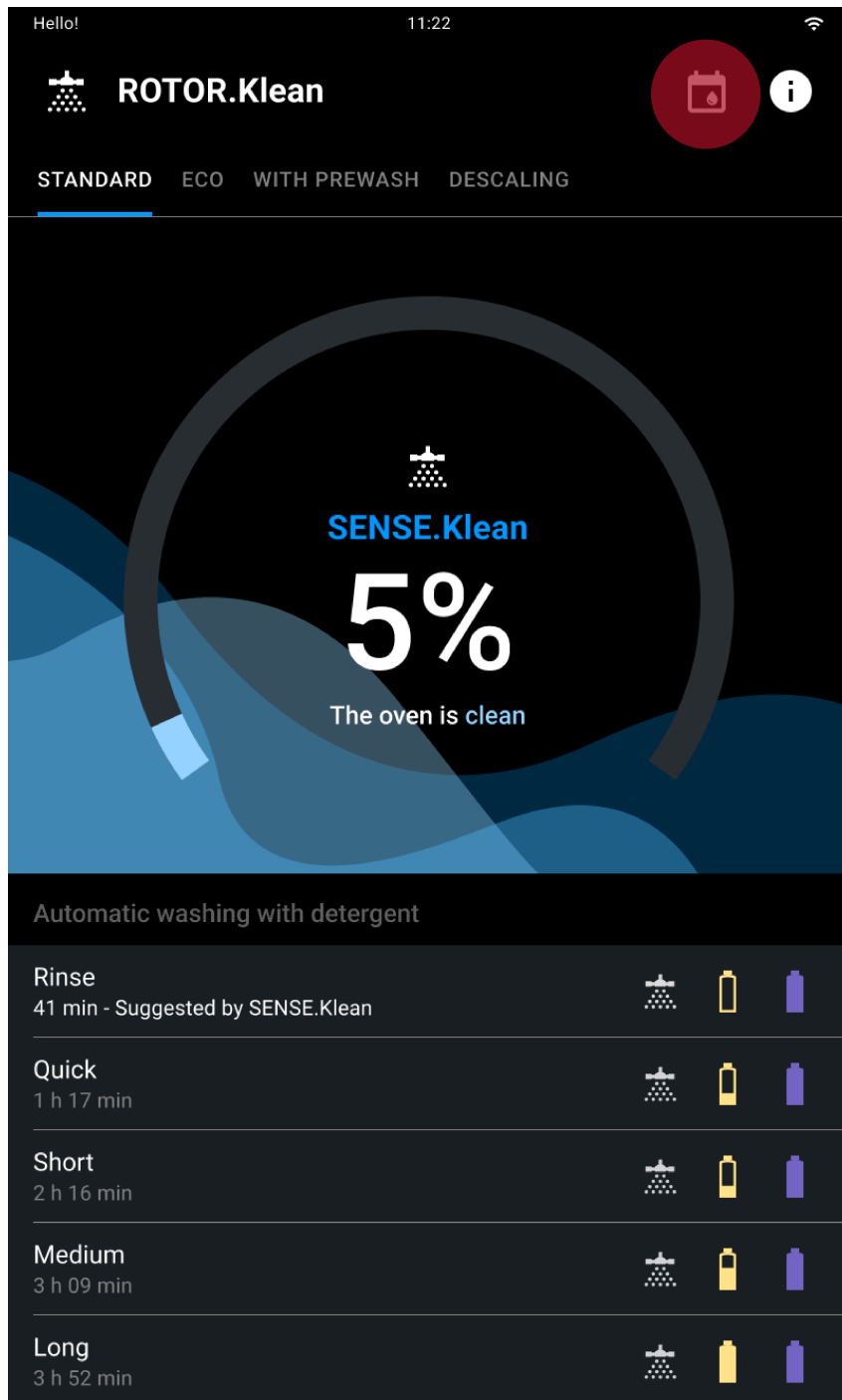

Tap the "Add" icon to create a new wash timer.

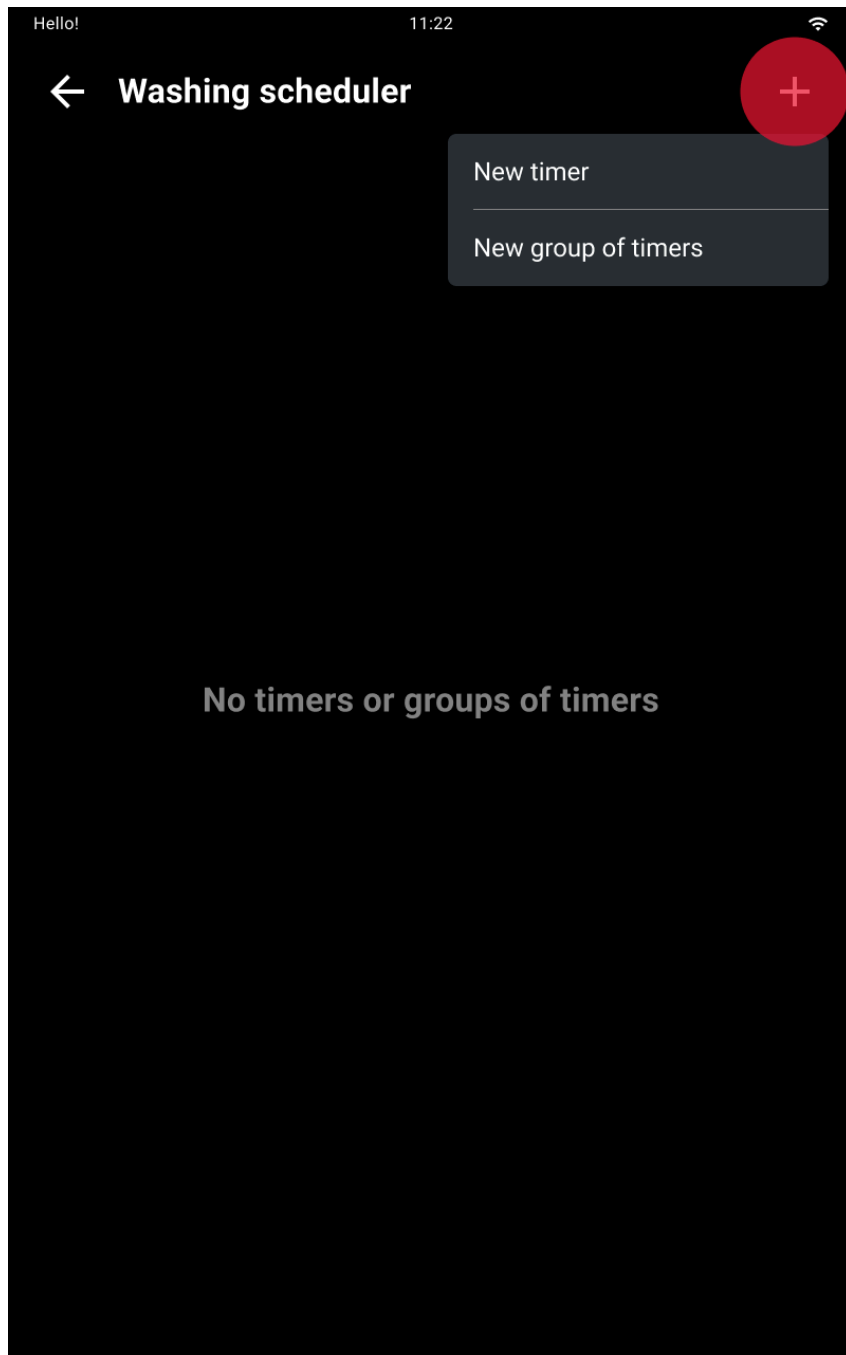

Enter a timer name, wash type, start time, weekly frequency (optional) and enable automatic start of scheduled washes if desired.  
Once you have completed the required fields, save the scheduling.

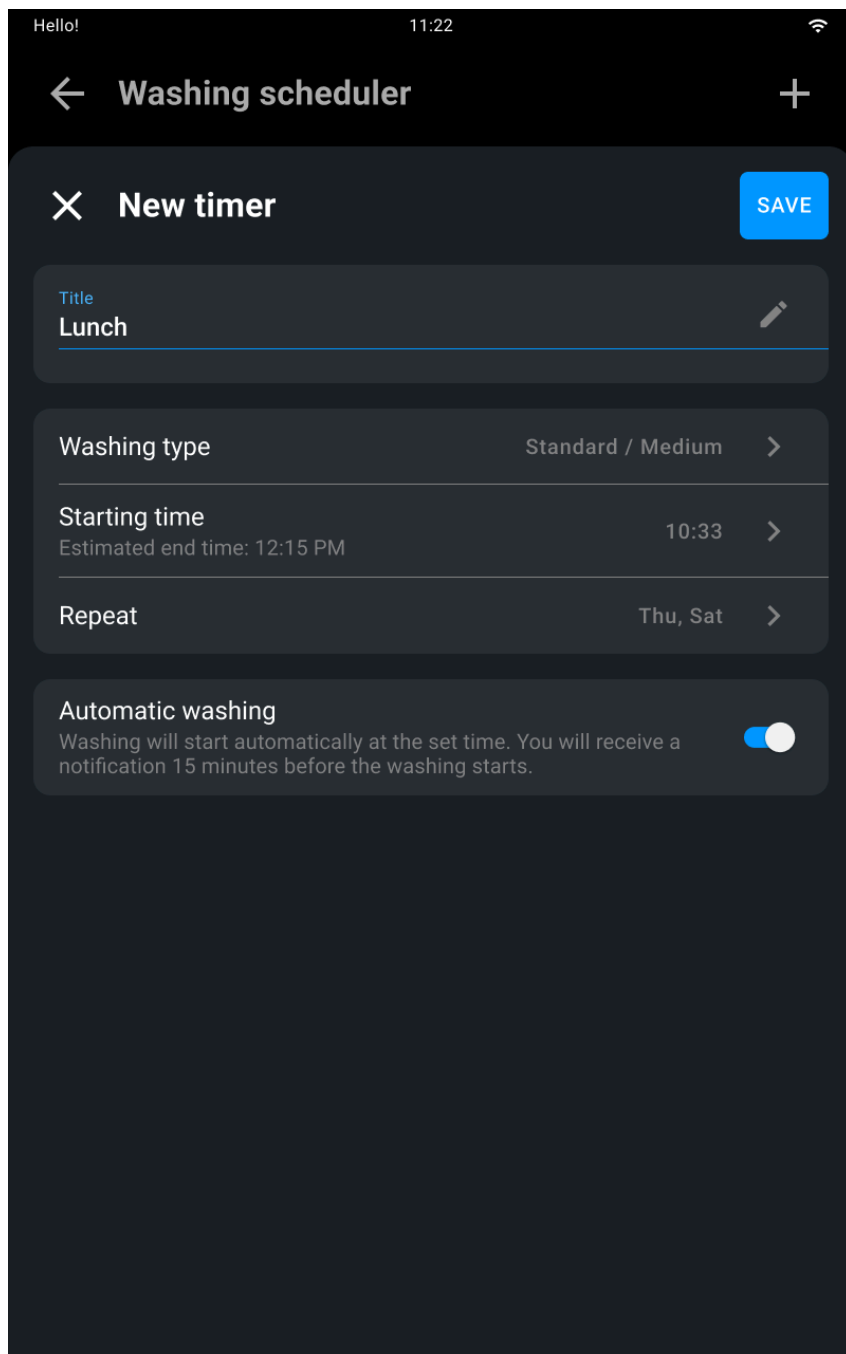

## Creating a wash schedule group

Tap the "Add" icon to create a new wash timer group.

Hello!

11:22



← Washing scheduler



New timer

New group of timers

No timers or groups of timers

Enter group name.

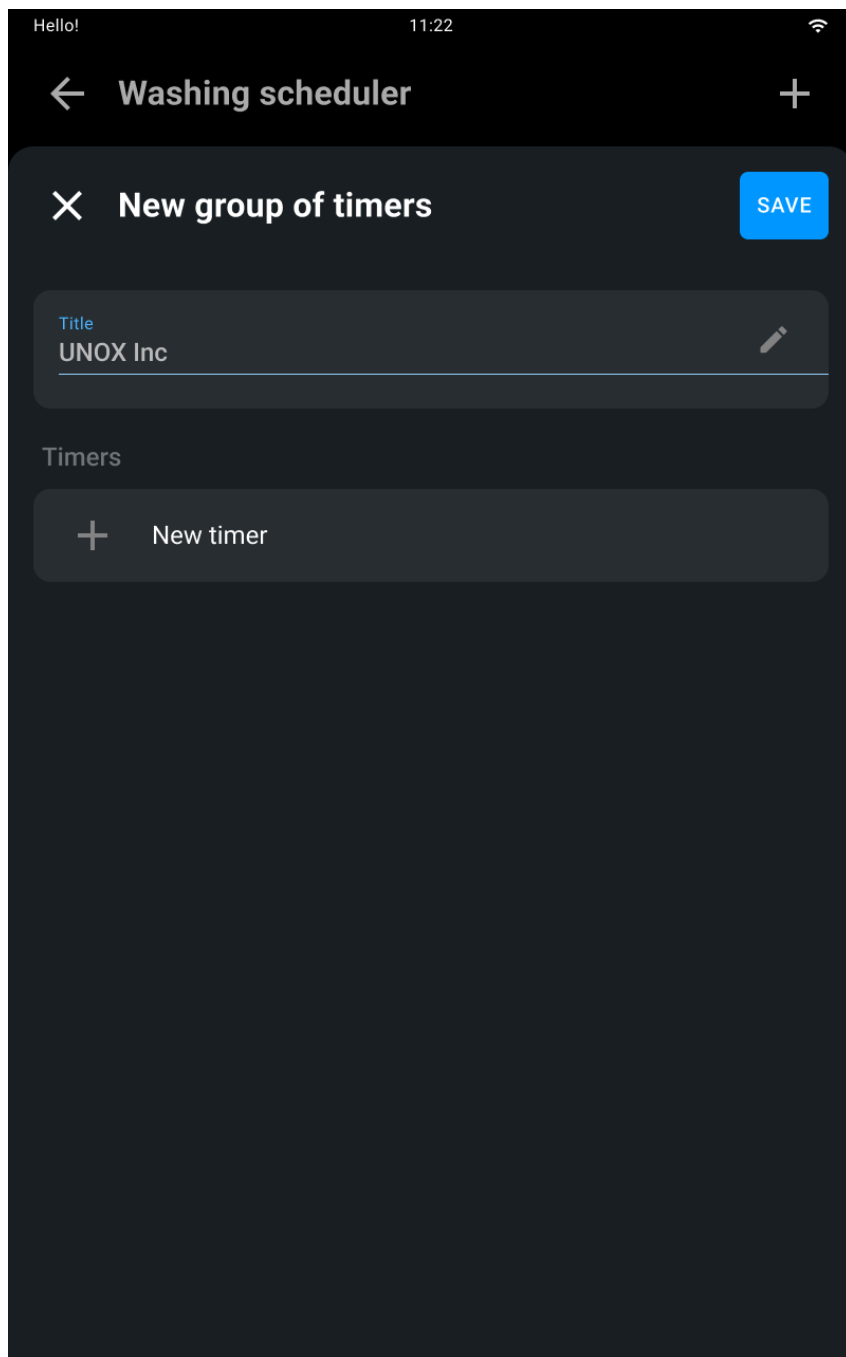

Creating new individual timers within the group. Once you have completed the required fields, add the timer to the schedule.

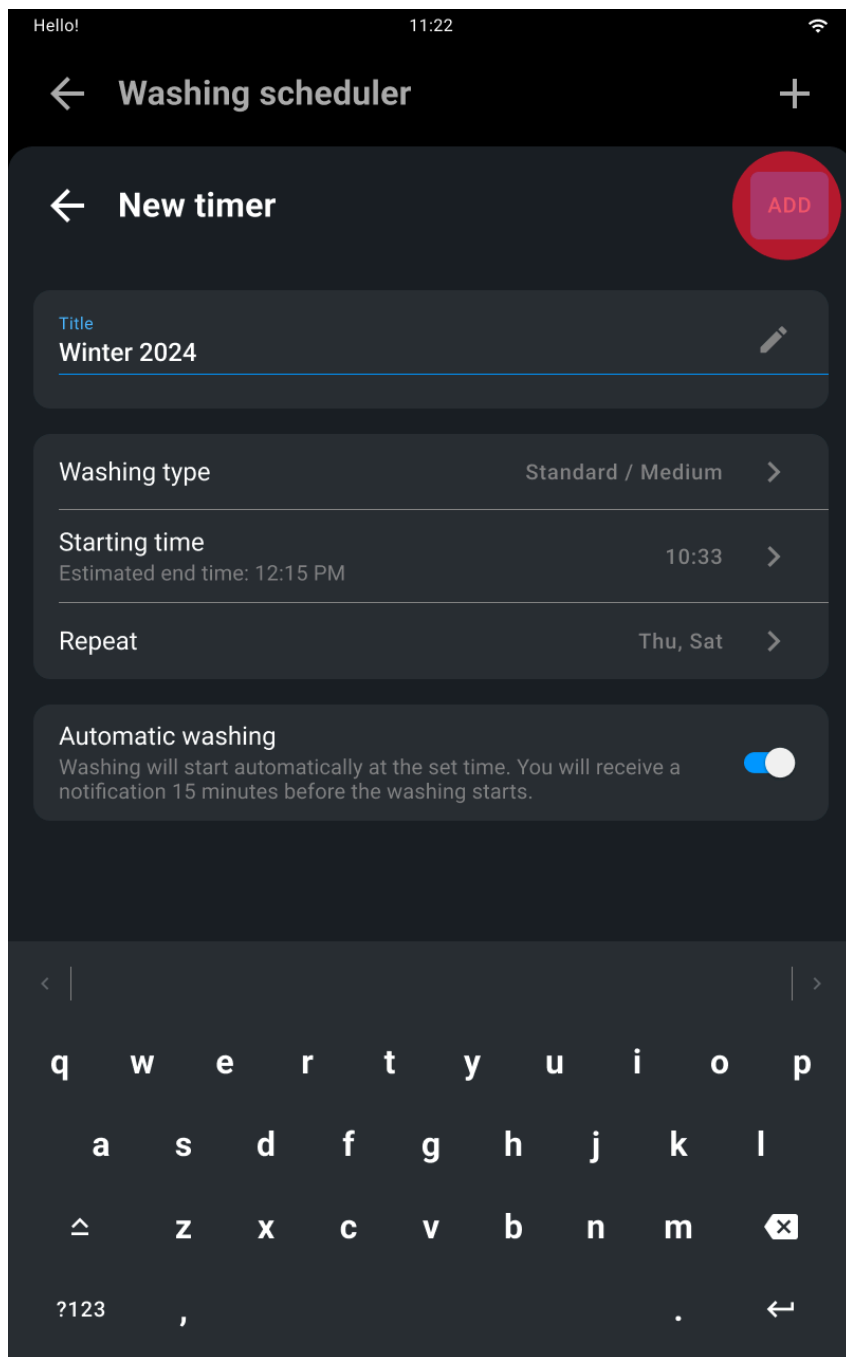

Once the desired timers have been added, save the scheduling.

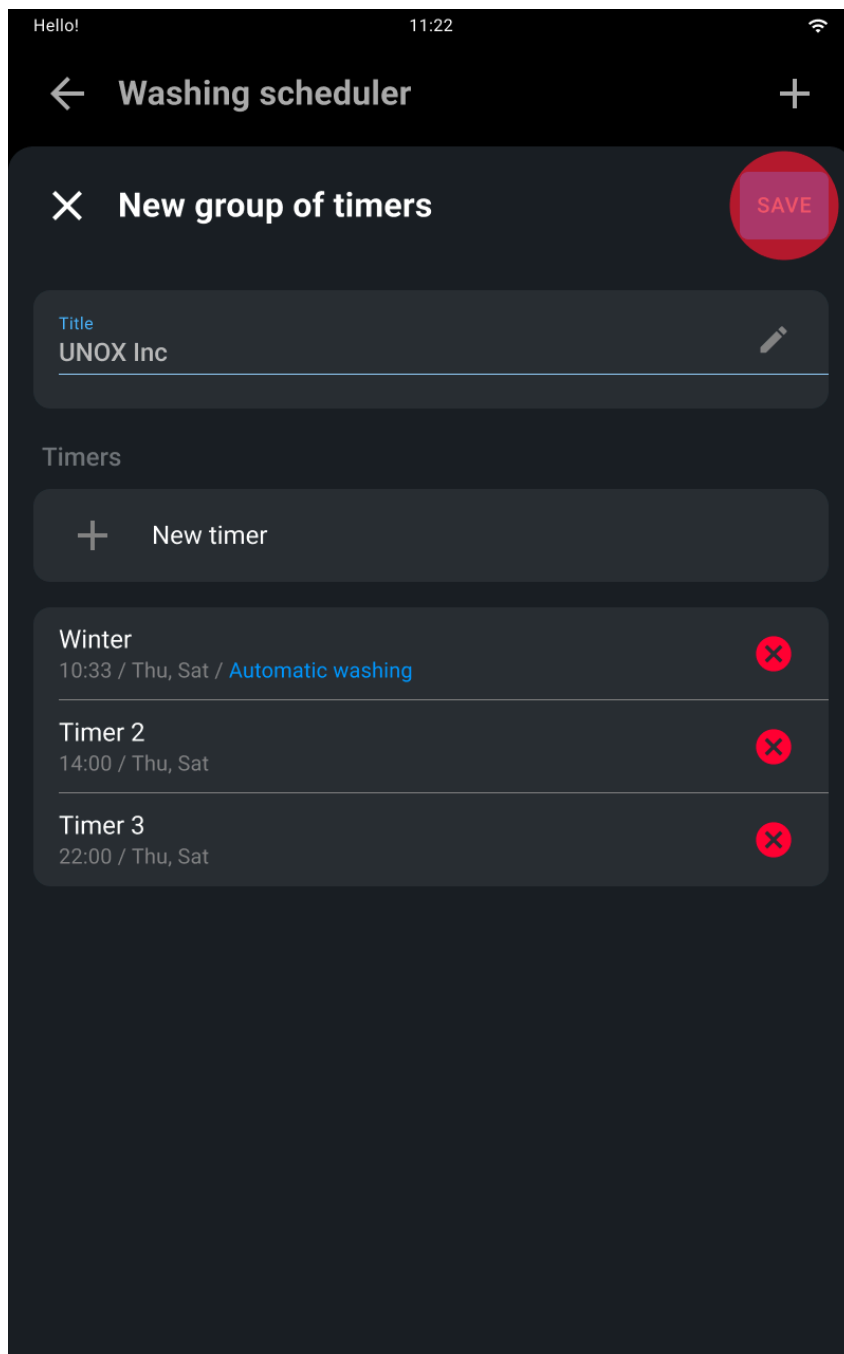

## Enabling a timer or group of timers

You can enable or disable a timer or group of timers from the landing page using via the switch button on the right.

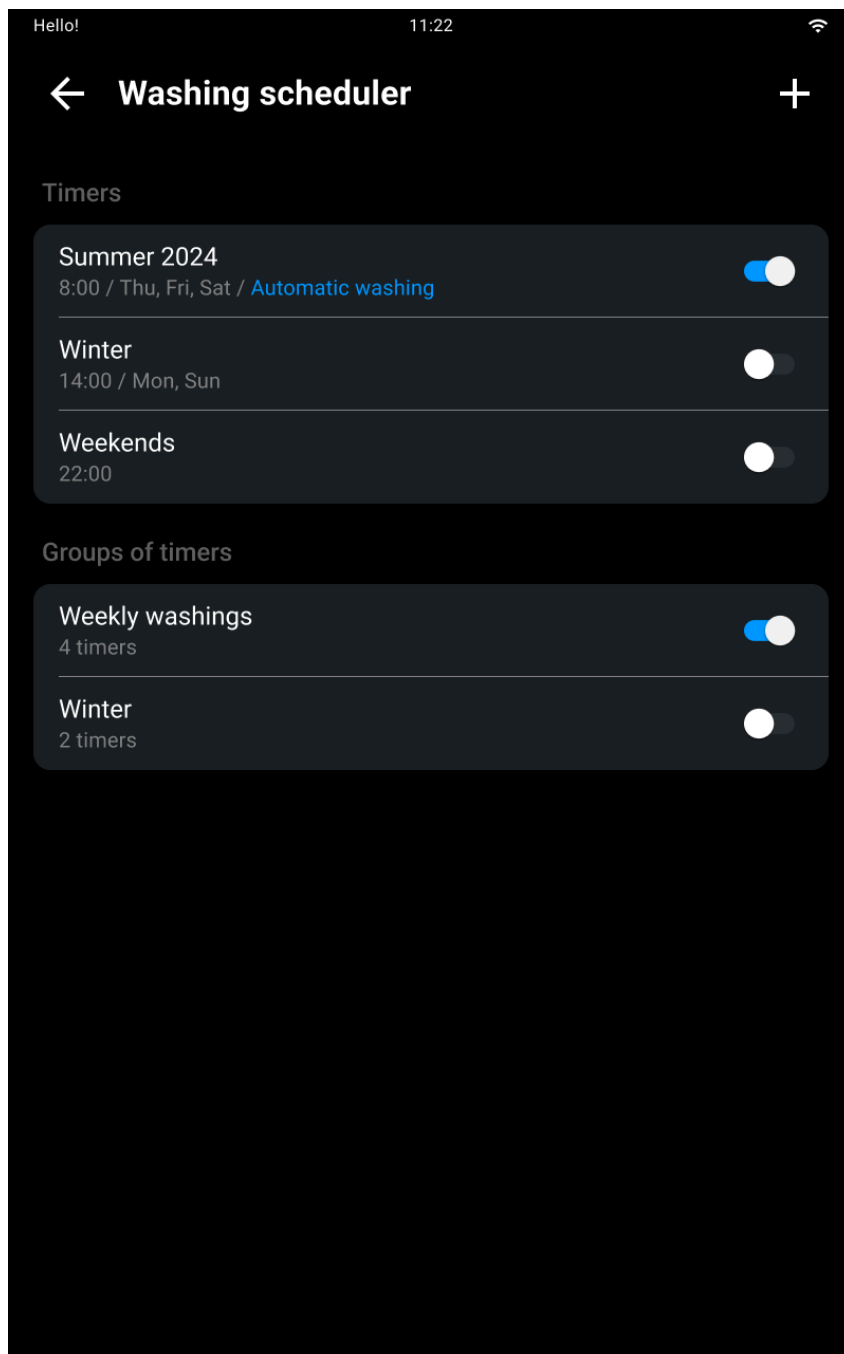

## Editing or deleting a timer

Tap the list of the desired timer to edit or delete it. Changes can only be applied if a change is made.

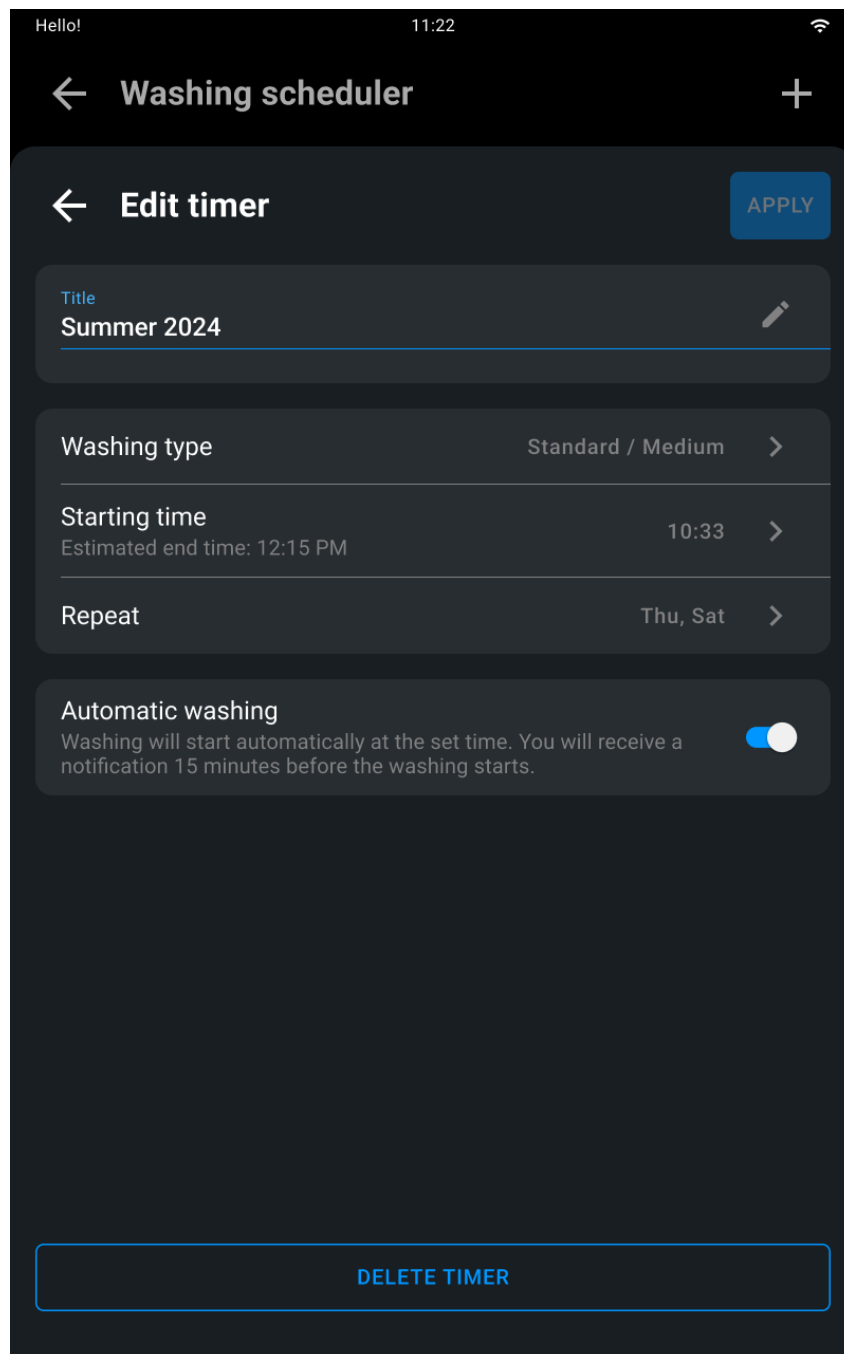

## Editing or deleting a group of timers

Tap the list of the desired timer group to edit or delete it. Tap a timer again to edit or delete it. Changes can only be applied if a change is made.

← Washing scheduler



✕ Edit group of timers

APPLY

Title

Summer 2024



Timers

+ New timer

Winter

05:00, Thu and Sat



Timer 2

05:00, Thu and Sat



Timer 3

05:00, Thu and Sat



DELETE GROUP

# Wash start notifications

- When the automatic start option is enabled, a notification shows 15 minutes before the scheduled wash.
  - When the automatic start option is disabled, a notification of the scheduled wash shows at the scheduled start time. Confirm to start washing.
  - If some wash programmes are not performed because the oven is switched off, once the oven is switched back on again, the system will ask if you want to start the last missed programme.
  - If another process is running on the oven at the wash scheduling start time, the system will show a warning that washing cannot be started.
  - If the oven door is open when the automatic wash is due to start, the system will show a warning that washing cannot be started.
-

# Refilling Det&Rinse

A note on the display tells you when you need to refill the Det&Rinse tank.

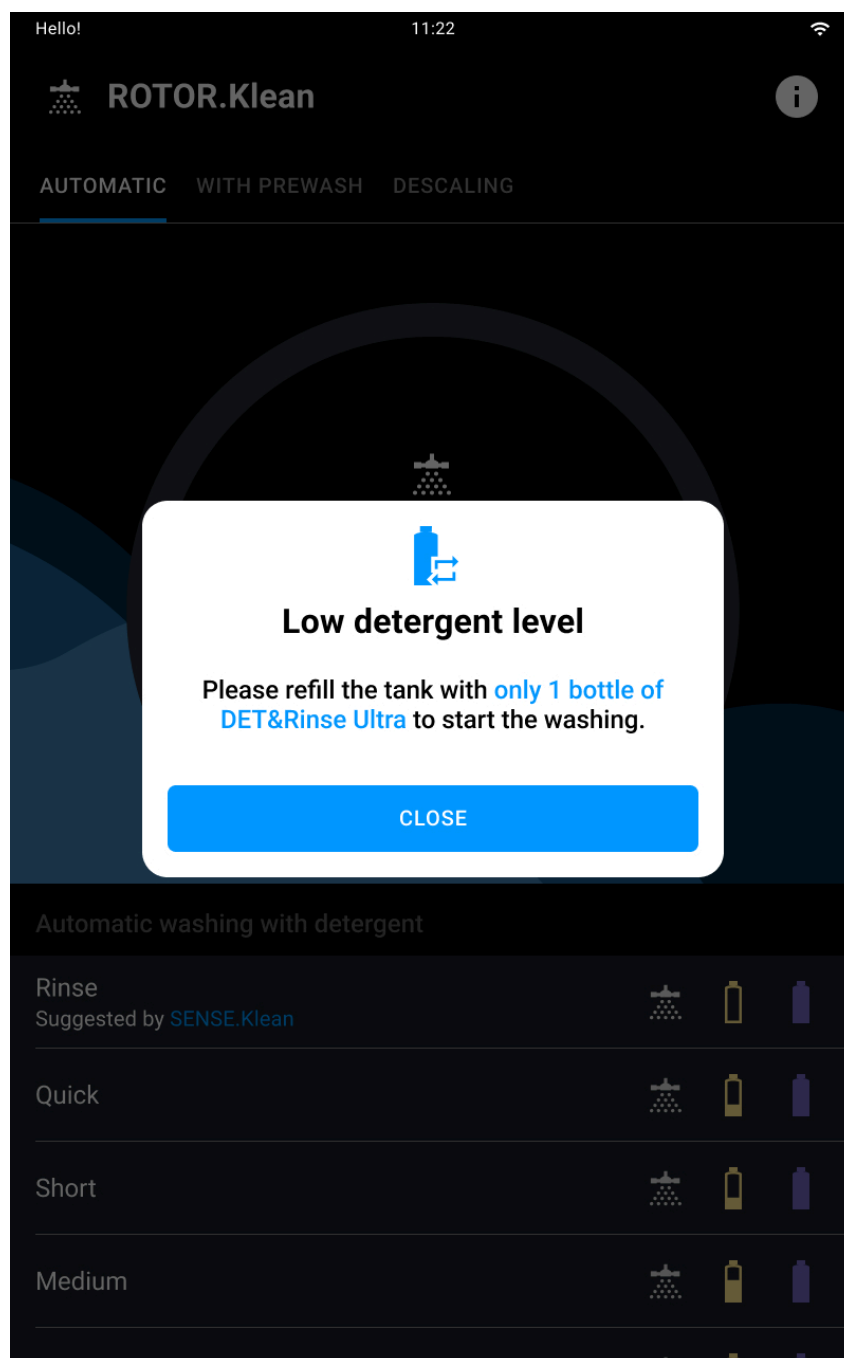

You must only refill the tank with 1 litre | 0.26 US Gal bottles of UNOX Det&Rinse™ Ultra detergent, the only one approved and tested for washing the oven cavity.



Wear gloves to prevent your hands from coming into direct contact with the detergent. The detergent must not come into contact with the skin, eyes or mucous membranes. In case of contact with the detergent, follow the instructions on the safety data sheet.

- press and release the tank cover and take out the tank;

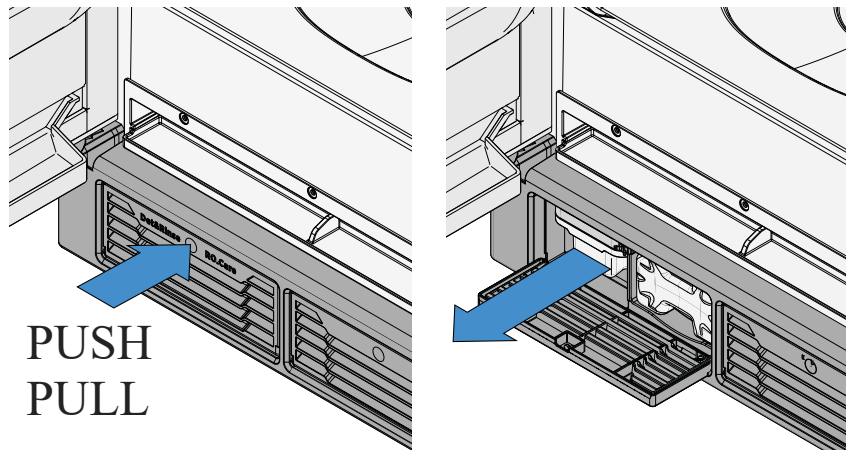

- remove the cap from the UNOX Det&Rinse™ Ultra bottle, holding it with the cap facing upwards; DO NOT remove or pierce the protective film;

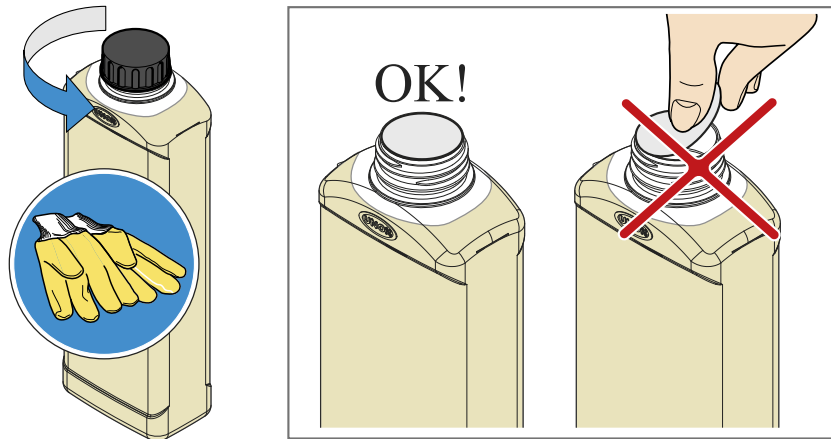

- check that the protective film is intact and undamaged. Turn the bottle upside down and screw it onto the tank; a pin will break the protective film, which allows the detergent to pass safely into the tank.

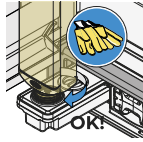

- When the bottle is completely empty, remove it, making sure it doesn't drip; dispose of it as prescribed by current regulations.

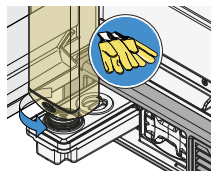

Put the tank back in until it can go no further. Dispose of the gloves without touching the areas wet with detergent.

---

# Replacing the RO.Care filter

The oven features an RO.Care softener filter that must be replaced once a year or after the treatment of a number of litres calculated using this formula:

Litres (L) =  $13000 \mid 343.4 \text{ Us Gal} / \text{Temporary hardness (}^\circ\text{DH)}$  in relation to the hardness of the customer's mains water.

In both cases a note on the display tells you when you need to replace it.

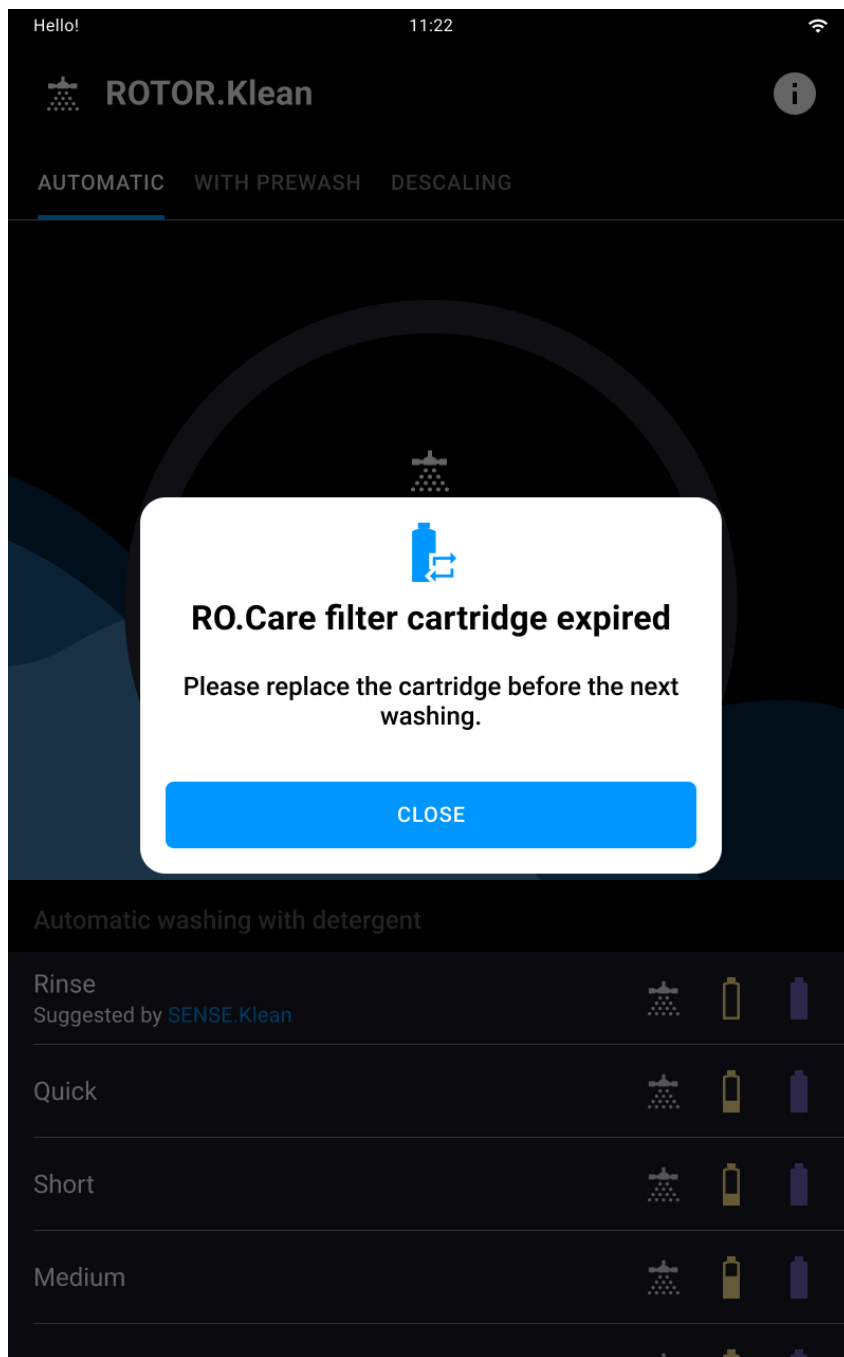

- press and release the RO.Care softener filter cover and take out the empty filter by pulling it outwards;

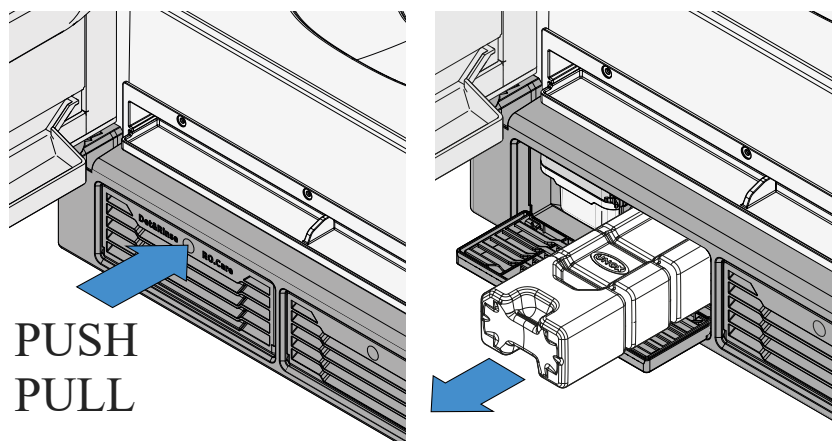

- remove the protective cover from the new filter;

- insert the new filter, making sure that you insert it in the correct direction.

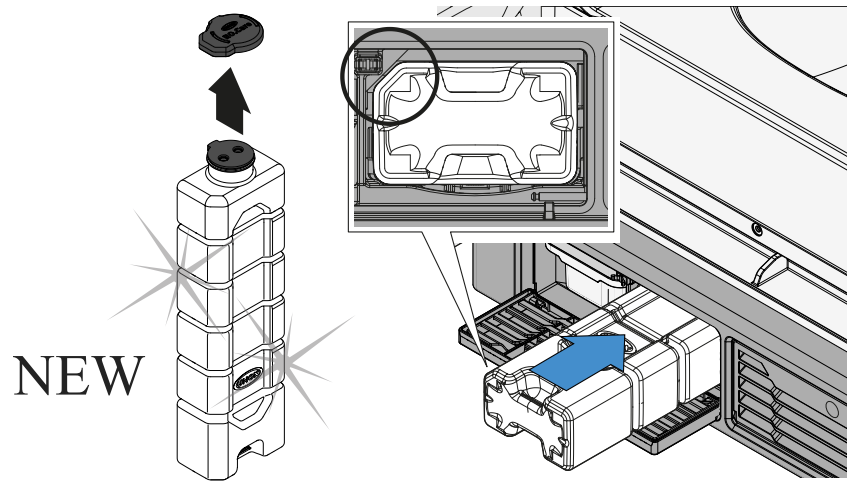

# 7. Apps

- [Cooking Set](#)
  - [Library](#)
  - [Chefunox - Speedunox](#)
  - [MULTI.Time](#)
  - [MULTI.Speed](#)
  - [Washes](#)
  - [DDC \(Data Driven Cooking\)](#)
  - [Support](#)
-

## Apps



# Cooking Set

- [Selecting a preset cooking program](#)
  - [Editing a preset cooking program](#)
  - [Activating a UIP technology](#)
  - [Adding a new cooking step](#)
  - [Preheating](#)
  - [Starting a cooking cycle](#)
  - [Cooking cycle in progress](#)
  - [Ending a cooking cycle](#)
  - [Cooking summary](#)
  - [Actions after cooking](#)
  - [Saving a manual cooking cycle at the end of cooking](#)
-

Cooking Set lets you start a manual cooking cycle.

In manual cooking cycles you must set the following parameters independently:

- **cooking time** or **core temperature** (if applicable);
- **cavity temperature** or **Delta T** (if applicable);
- **input** or **extraction of steam into/from cavity**;
- **speed** of fans in standard or pulse modes;
- **microwave** or **defrosting modes** (only for Speed ovens).

Each manual cooking cycle is always composed of:

- **SMART.Preheating** or manual preheating;
- up to **nine cooking steps**, even with different cooking parameters.

After setting all the parameters, you can either:

- start the cooking cycle without saving it;
  - save the recipe set and then start the cooking cycle (saved recipes are stored in the [Library app](#)).
-

# Landing page display and explanation

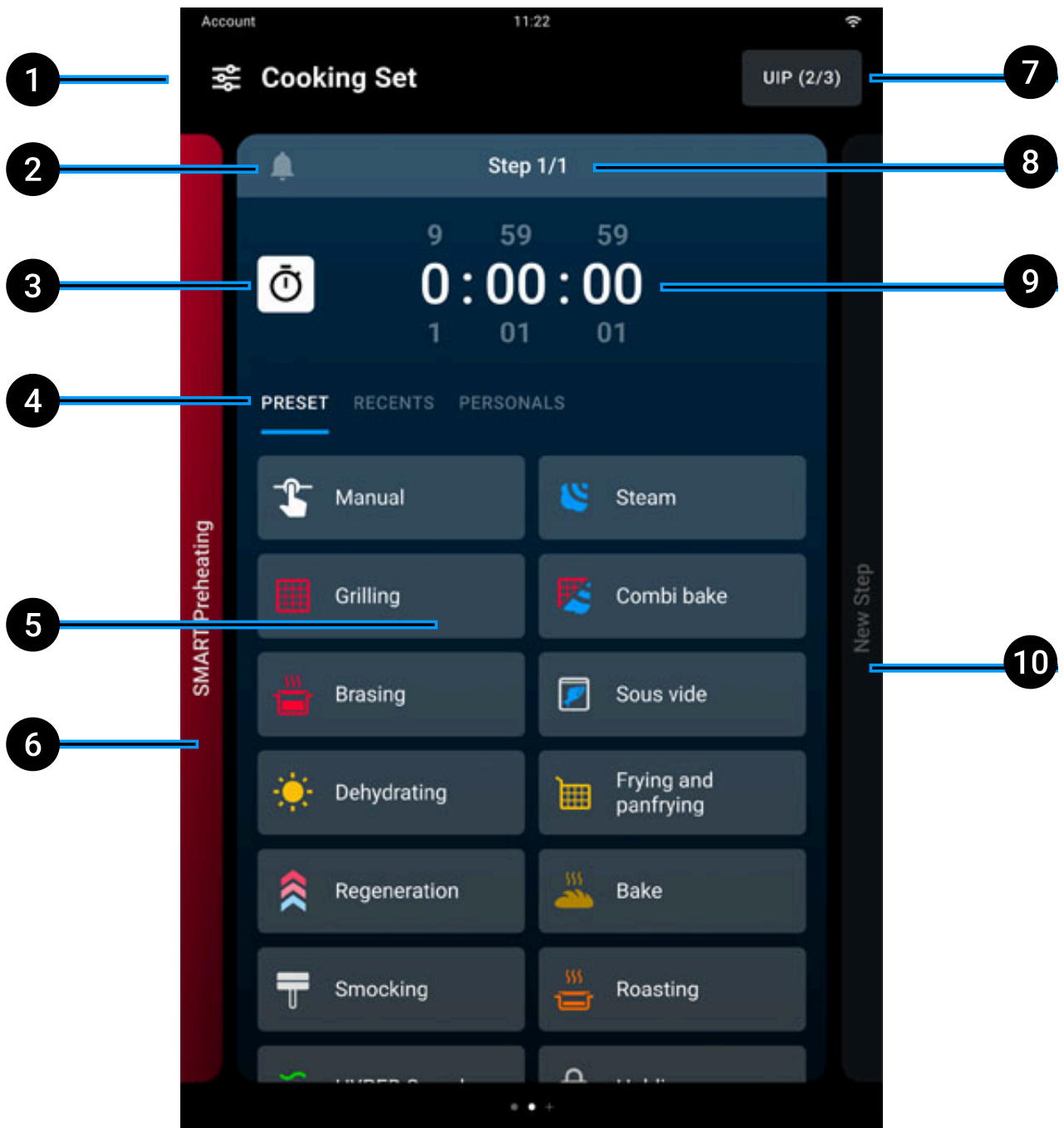

- 1 section name;
  - 2 activation/deactivation of cooking notifications;
  - 3 selection of timer;
  - 4 selection of preset category;
  - 5 preset card selection;
  - 6 preheating;
  - 7 UIPs setting;
  - 8 number of steps;
  - 9 cooking time;
  - 10 next step.
- 

## Selecting a preset cooking program

To start or create a manual cooking cycle, you must set the cooking time and select either:

- a preset program with parameters **already filled in** based on the most popular types of cooking. See how to [edit a UNOX preset program](#) here.
- a **Manual** preset program, fully customisable, that sets no limits to parameters. See how to create a personal preset program for future use here.

To select the preset program you want tap its name.

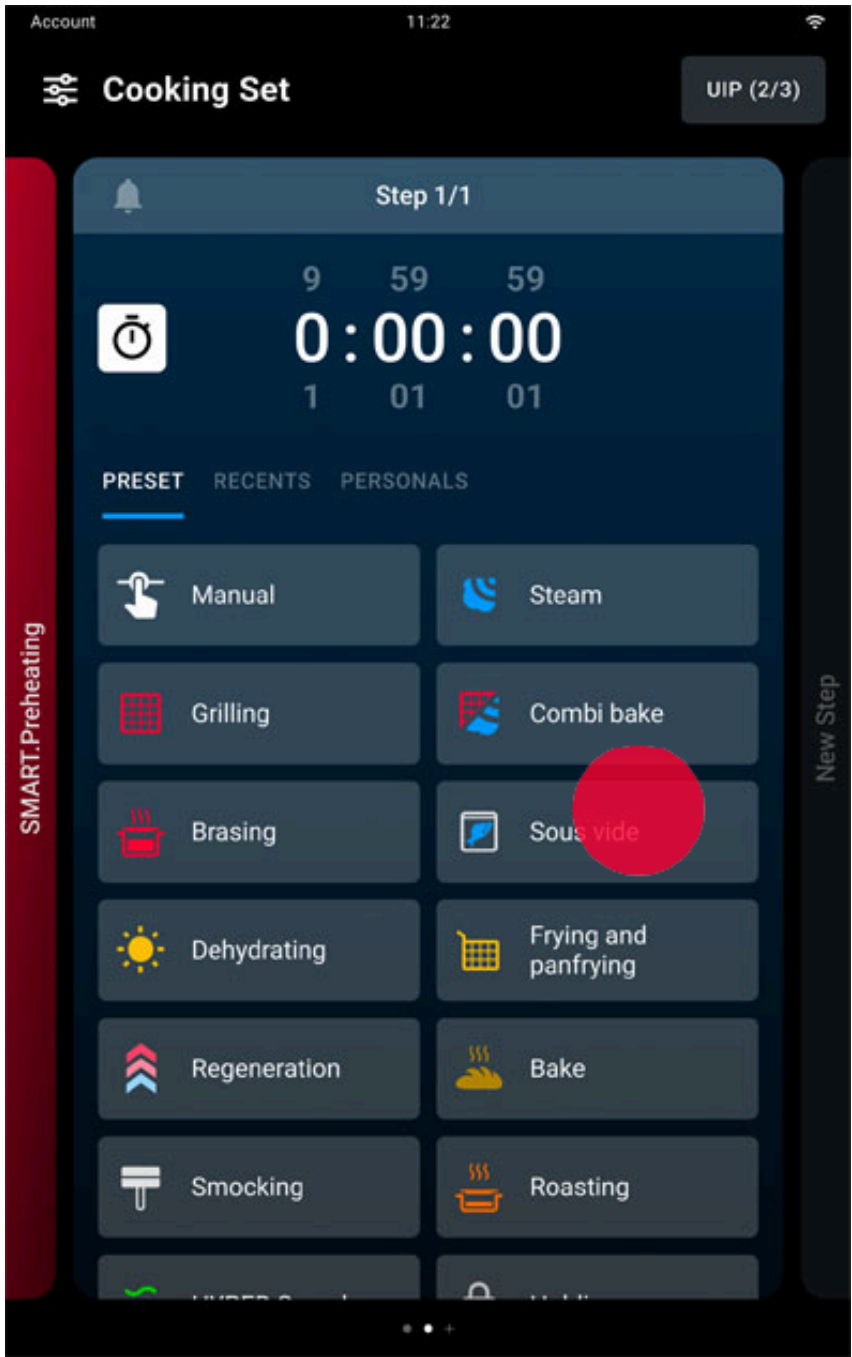

## A special preset program: **HYPER.Speed**

SPEED mode lets you cook food quickly using heating elements (convection cooking) and microwaves (you can set the percentage as you wish. However, we recommend a value of 20% - 30%).

This is indicated for bakery products that require short cooking times and to re-heat them quickly.

For best results, use the SPEED.Plate tray, designed specifically for this cooking mode.

The **SPEED.Plate** tray, supplied with the appliance, is made entirely of 7 mm thick aluminium; it must be preheated in the oven to accumulate as much heat as possible that will then be transferred by conduction to the dishes to be cooked, crisping them up.

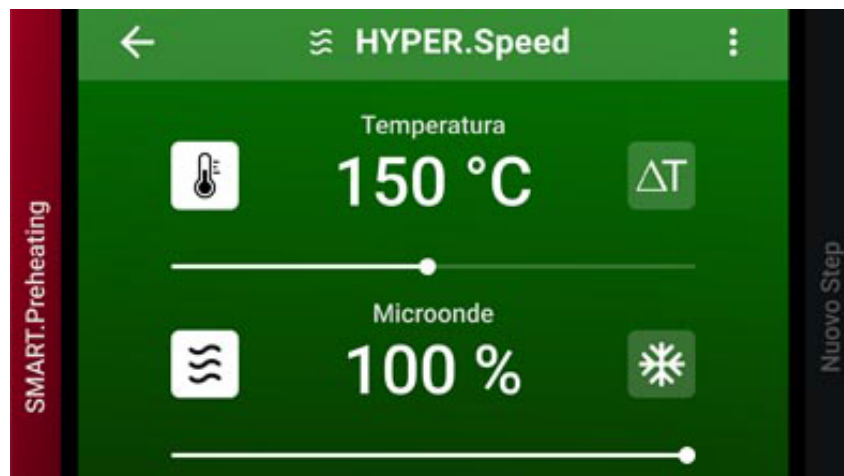

# Editing a preset cooking program

After selecting the preset cooking program, if you wish, you can edit the preset parameters to suit your needs.

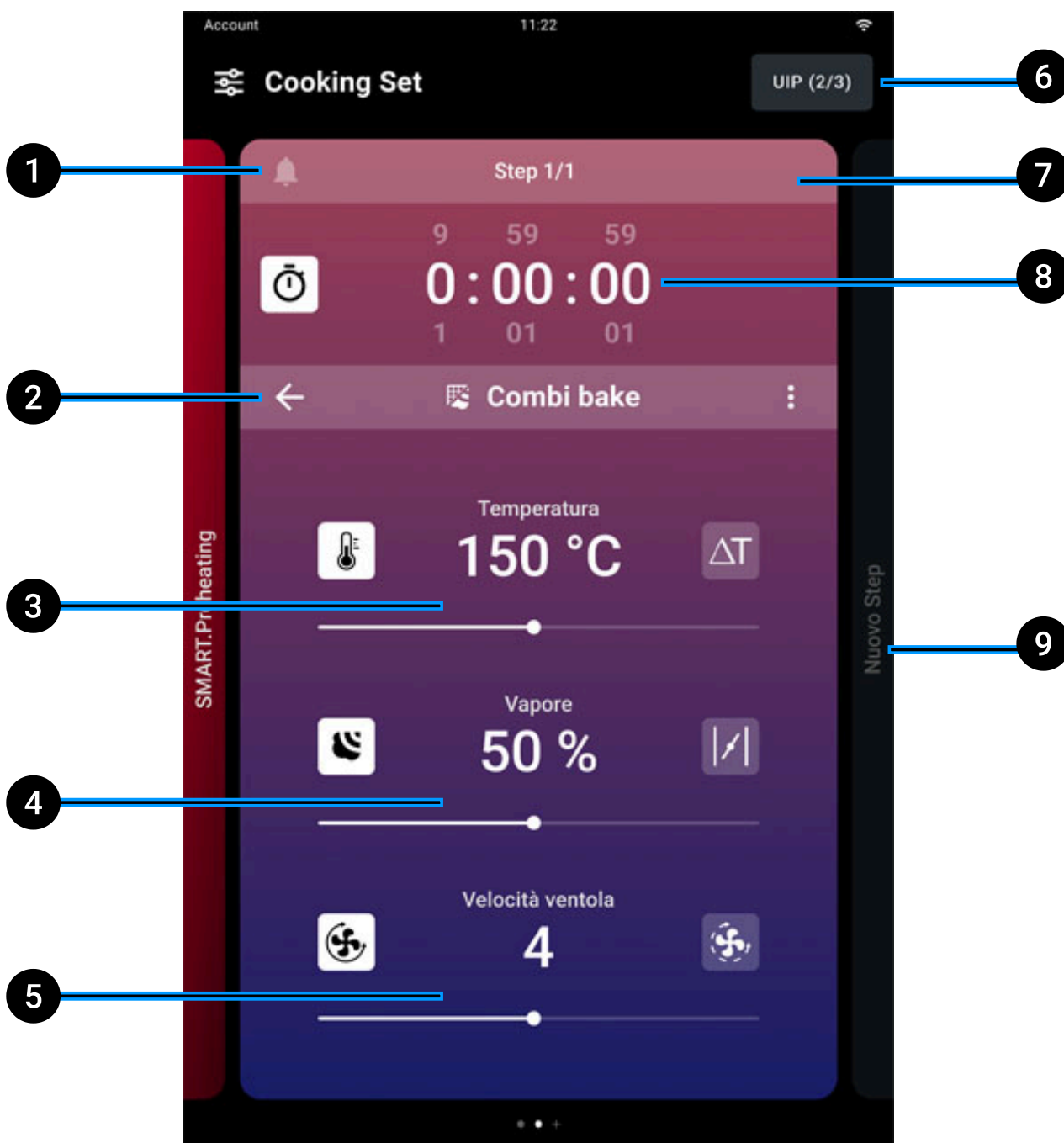

- 1 **cooking notifications:** you can activate customised cooking notifications that will appear between one cooking step and another;
  - 2 **back:** you can go back to the **choice of preset program** to select another one;
  - 3 **edit cooking temperature** from 30 to 260° C. For particularly delicate cooking cycles you can use the Delta T function, from 0 to 120° C (if available). In this case you must use the core probe, inserting it into the heart of the food. By definition, Delta T maintains a constant temperature difference between the temperature in the cavity and the probe temperature, using the formula: Cavity temperature minus core probe temperature;
  - 4 **edit steam release** STEAM.Maxi or removal DRY.Maxi;
  - 5 **edit speed of fans** in standard or pulse modes. If the fans are in pulse mode, they turn off when the oven reaches the temperature set;
  - 6 **UIP:** you can edit activation of the [Unox Intelligence Performance](#) technology (not recommended);
  - 7 **delete a cooking step** (only if there is more than one cooking step);
  - 8 **edit cooking time** from 0 mins to 9 hours 59 mins 59 secs, or alternatively the **core probe temperature** that the cavity must reach (if applicable). Choosing one of these parameters excludes the other;
  - 9 adding a **new cooking step**.
-

# Activating a UIP technology (Unox Intelligent Performance)

**UIP (Unox Intelligent Performance)** technologies allow the oven to constantly monitor each preheating and cooking process.

See further information about [UIP technologies \(Unox Intelligent Performance\)](#) here.

To edit the **Unox Intelligent Performance** cooking technology settings:

- tap the UIP button on the top right of the card;

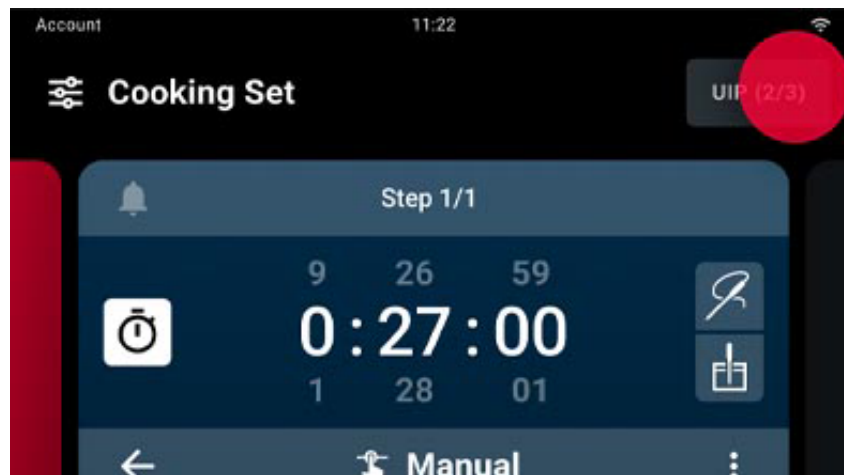

- activate or deactivate the use of the technology by moving the cursor;
  - to save and confirm changes, tap the apply button.
-

# Adding a new cooking step

How to add a new cooking step

If necessary you can create cooking programs with several steps; each step can have different parameters:

- tap the new step button on the edit preset card;

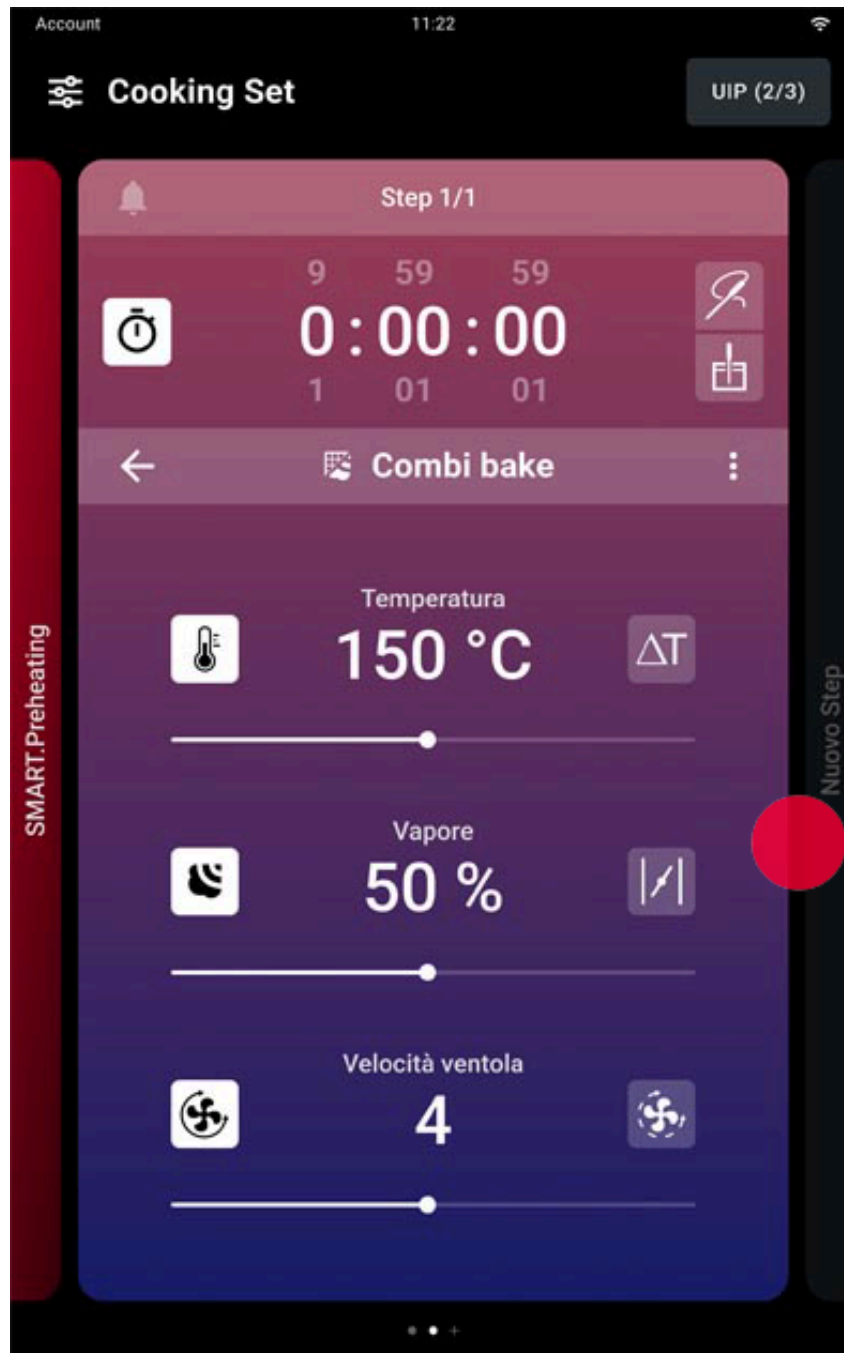

- [select a preset](#) cooking program for the new step;
  - [edit the preset program](#) as required.
- 

## Preheating

Before doing any cooking, it is very important to preheat the oven cavity correctly to temperature: therefore, when each cooking cycle starts, the oven is automatically preheated.

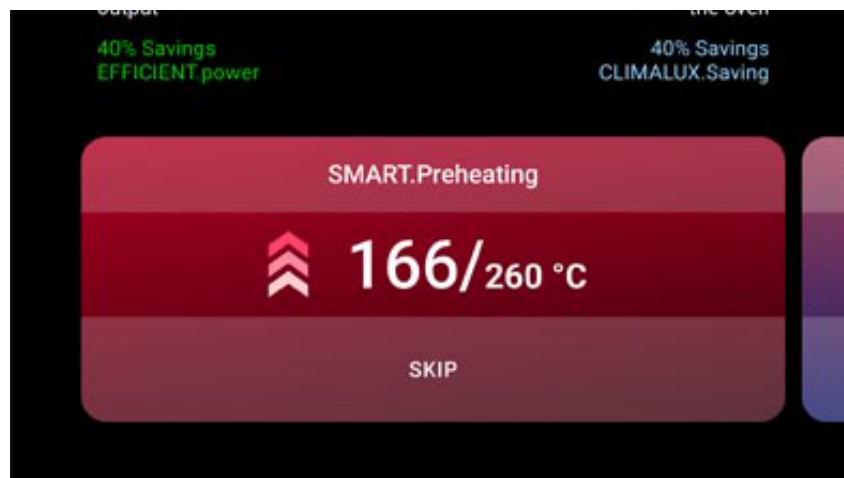

UNOX recommends that you use SMART.Preheating, an automatic preheating program that autonomously sets the preheating time and temperature; it also takes into account the dispersion of heat when you open the door and is activated when the oven moves from one step to the next, adjusting the oven cavity to the step's new parameters.

---

## Deactivating SMART.Preheating (not recommended)

To deactivate SMART.Preheating technology and manually set preheating, tap the preheating card and deactivate the technology by moving the cursor. To save the changes, tap the apply button. Then you must set the preheating **time** and **temperature** in the card that appears.

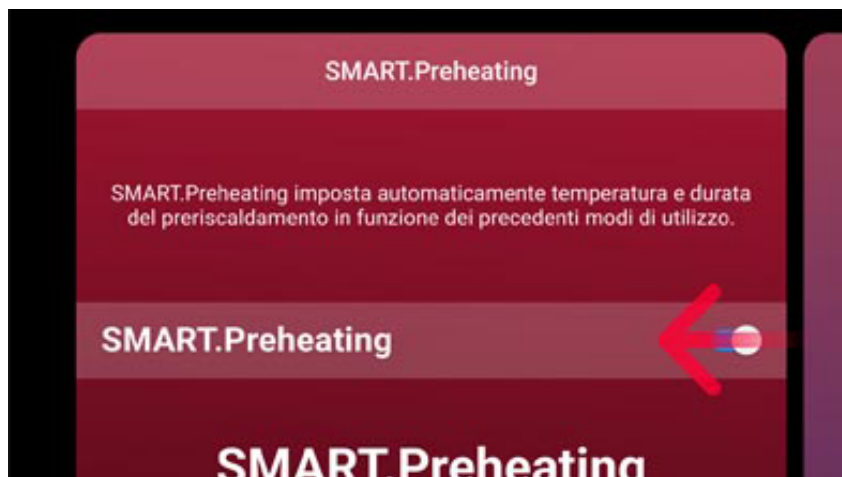

---

## Stopping preheating in progress

To stop preheating that's in progress at any time, whether manual or SMART.Preheating, press the SKIP button and confirm.



# Starting a cooking cycle

Tap START/STOP  $\frac{\text{START}}{\text{STOP}}$  to start the cooking cycle: a manual or Smart.Preheating phase begins, depending on what you have previously set.



To stop preheating that's in progress at any time, whether manual or SMART.Preheating, press the SKIP button and confirm.

See further information about [preheating](#) here.

When preheating is completed or after it has been stopped prematurely, a screen will remind you to put the food into the oven; when the door is closed the first step scheduled automatically starts.

---

# Cooking cycle in progress

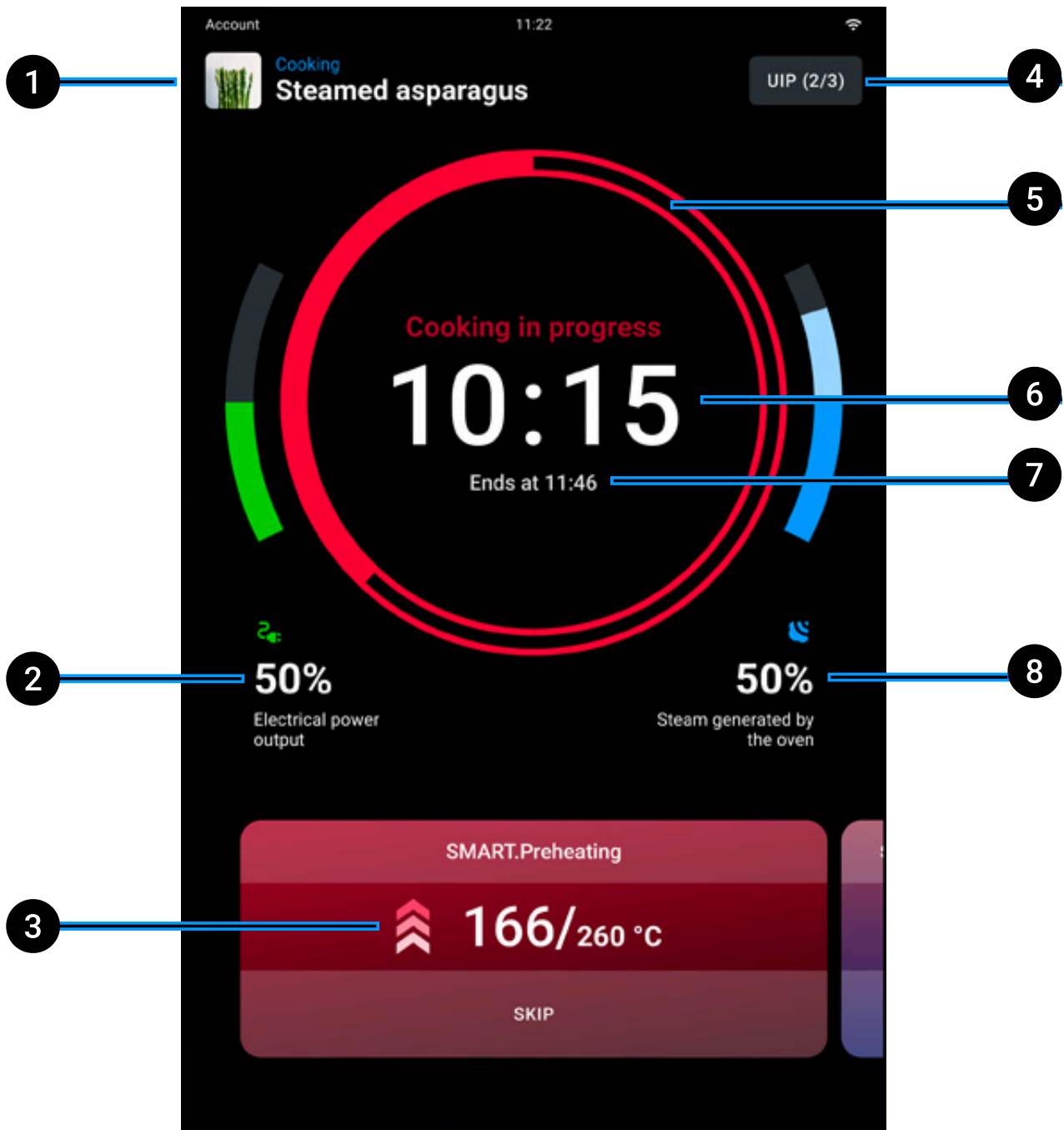

- 1 **name** of the recipe in progress (“Manual program” = recipe not saved);
  - 2 **monitoring** the power output;
  - 3 **parameters set** in progress: tap the card to change the cooking parameters or add other cooking steps. The changes are valid only for the cooking cycles in progress (the UNOX preset programs cannot be permanently edited); if you drag the card to left or right the preheating card and card for subsequent steps are displayed respectively (if any);
  - 4 **UIP**: you can edit activation of the [Unox Intelligence Performance](#) technology (not recommended);
  - 5 **cooking cycle end bar**: the colour of the bar gives an intuitive indication of the end of the cooking cycle:
    - if > 15 seconds the time bar is **red**
    - if < 15 seconds the time bar is **yellow**
    - if < 5 seconds the time bar is **green**
  - 6 **total cooking time**;
  - 7 **end of cooking** time;
  - 8 **monitoring** steam generated.
-

# Ending a cooking cycle

Cooking cycles end when the anticipated time elapses or when the core temperature set is reached (if applicable).

If you tap and hold down the START/STOP button  the cooking cycle in progress stops.

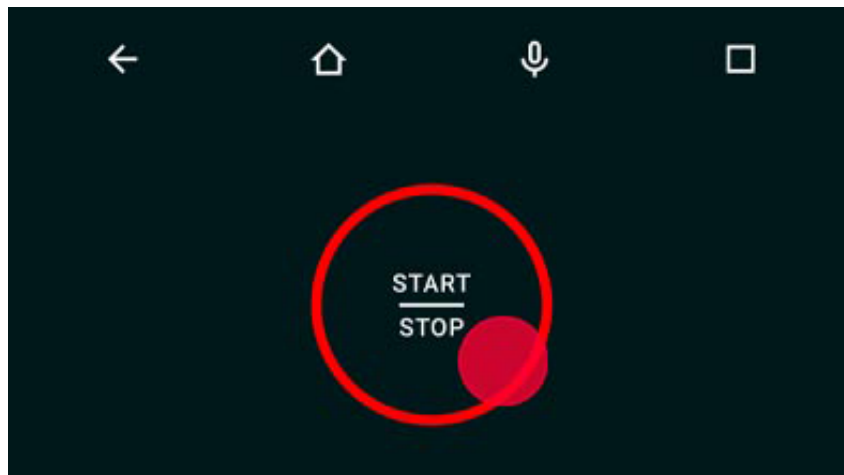

# Cooking summary

At the end of the cooking cycle a summary card will appear and a buzzer will sound that you can stop by tapping the STOP BUZZER button.

Then a card appears summarising consumption and possible actions after cooking.

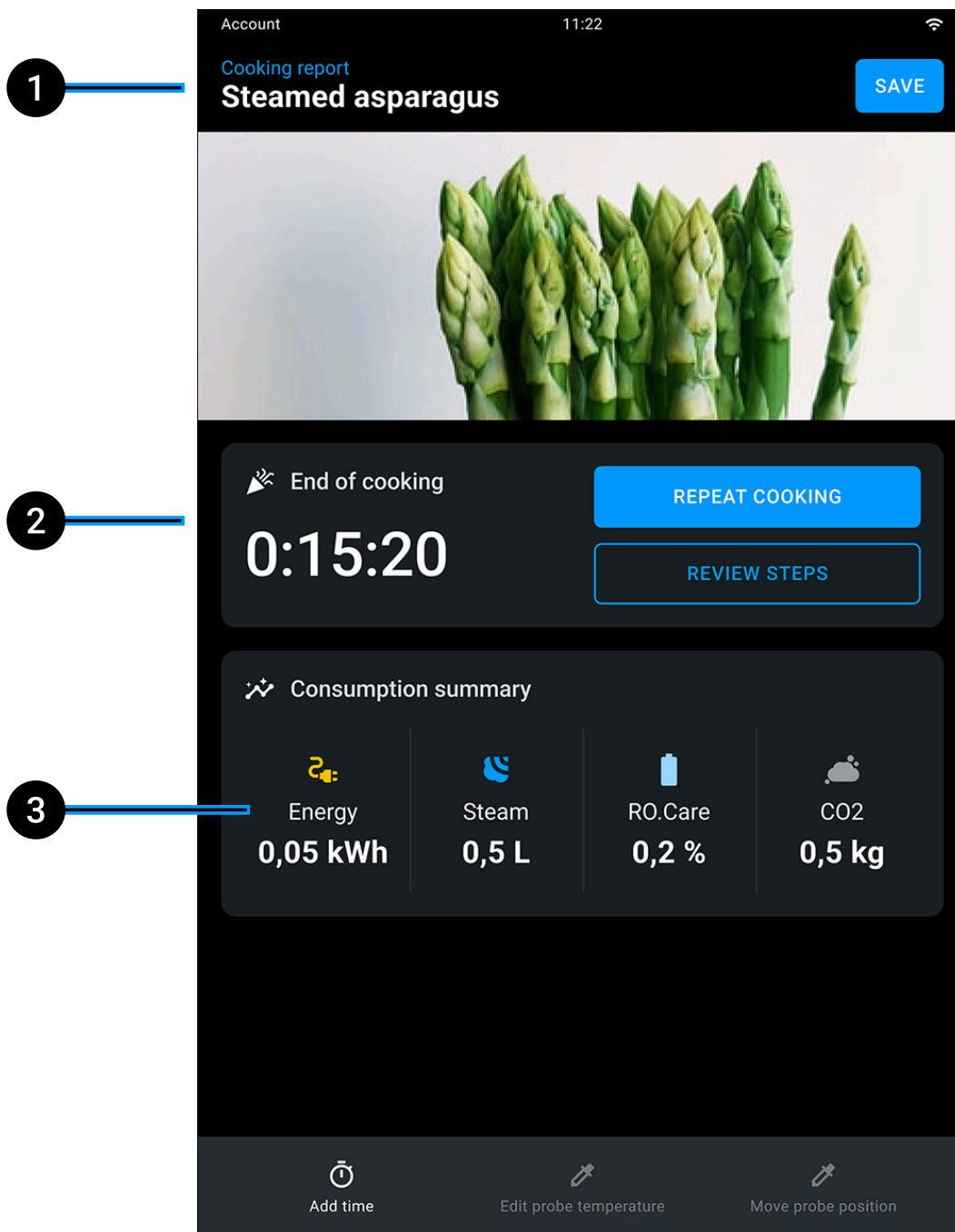

- 1 **name** of the recipe in progress;
  - 2 **duration** of cooking cycle just ended;
  - 3 consumption **summary** (electricity, steam, RO.Care, CO<sub>2</sub>);
-

# Actions after cooking

The screenshot displays a mobile application interface for a cooking report. At the top, the status bar shows 'Account', the time '11:22', and a Wi-Fi signal icon. Below this, the text 'Cooking report' is in blue, and 'Steamed asparagus' is in white. A blue 'SAVE' button is in the top right corner. A large image of steamed asparagus is centered below the title. The 'End of cooking' section features a large digital timer showing '0:15:20', a blue 'REPEAT COOKING' button, and a white 'REVIEW STEPS' button. The 'Consumption summary' section is divided into four columns: Energy (0,05 kWh), Steam (0,5 L), RO.Care (0,2 %), and CO2 (0,5 kg). The bottom navigation bar includes three icons: a clock for 'Add time', a thermometer for 'Edit probe temperature', and a probe for 'Move probe position'. Five numbered callouts (1-5) point to specific UI elements: 1 points to the title, 2 to the 'SAVE' button, 3 to the 'REPEAT COOKING' button, 4 to the 'REVIEW STEPS' button, and 5 to the 'Add time' icon.

Account 11:22

Cooking report

**Steamed asparagus** SAVE

End of cooking

**0:15:20** REPEAT COOKING

REVIEW STEPS

Consumption summary

| Energy   | Steam | RO.Care | CO2    |
|----------|-------|---------|--------|
| 0,05 kWh | 0,5 L | 0,2 %   | 0,5 kg |

Add time Edit probe temperature Move probe position

- 1 name of the **recipe** in progress;
  - 2 **save** the cooking cycle just ended; see how to [save a cooking cycle](#) here.
  - 3 **repeat** the cooking cycle just ended with the same cooking parameters that can be changed as you require;
  - 4 **repeat** the last cooking step;
  - 5 **add time** by keeping the parameters for the last step carried out or change the temperature of the core probe (if there is one).
-

# Saving a manual cooking cycle at the end of cooking

At the end of the cooking cycle you can save the recipe you have created:

- tap SAVE;



- choose the **photo** and the **name** to be assigned to your recipe;

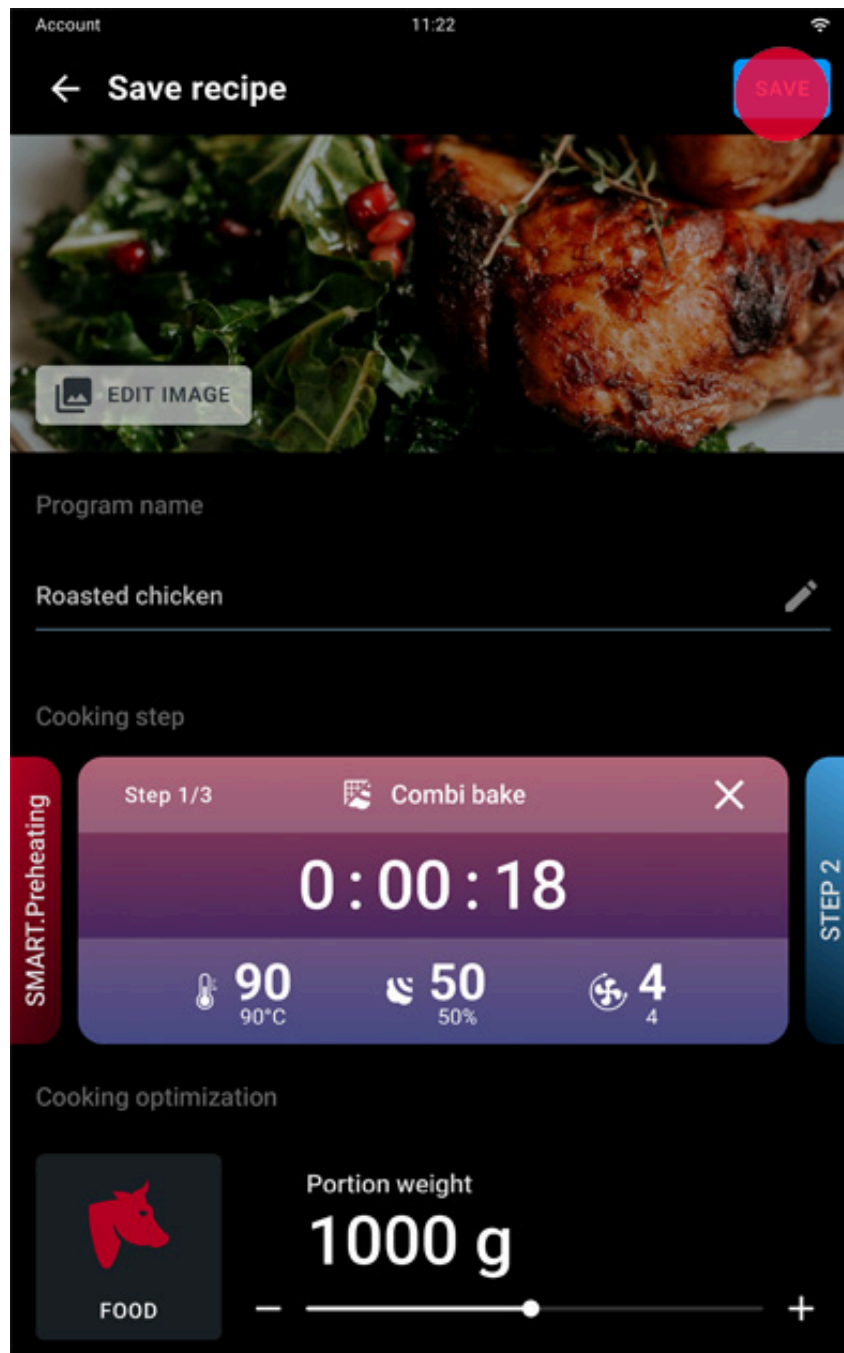

- confirm again with SAVE.

The recipes you have saved are collected in the [Library app](#): to start them, tap the recipe you are interested in and tap the START/STOP  $\frac{\text{START}}{\text{STOP}}$  button

## Apps



# Library

- [Browsing and selecting a recipe](#)
- [Recipe options](#)
- [Starting a recipe](#)
- [Creating a personal recipe](#)

---

The Library lets you create or start a personal recipe you've previously saved.

See how to [select and start a recipe](#) here.

See how to [create a personal recipe](#) here.

---

# Browsing and selecting a recipe

Tap the recipe you want in order to select it.



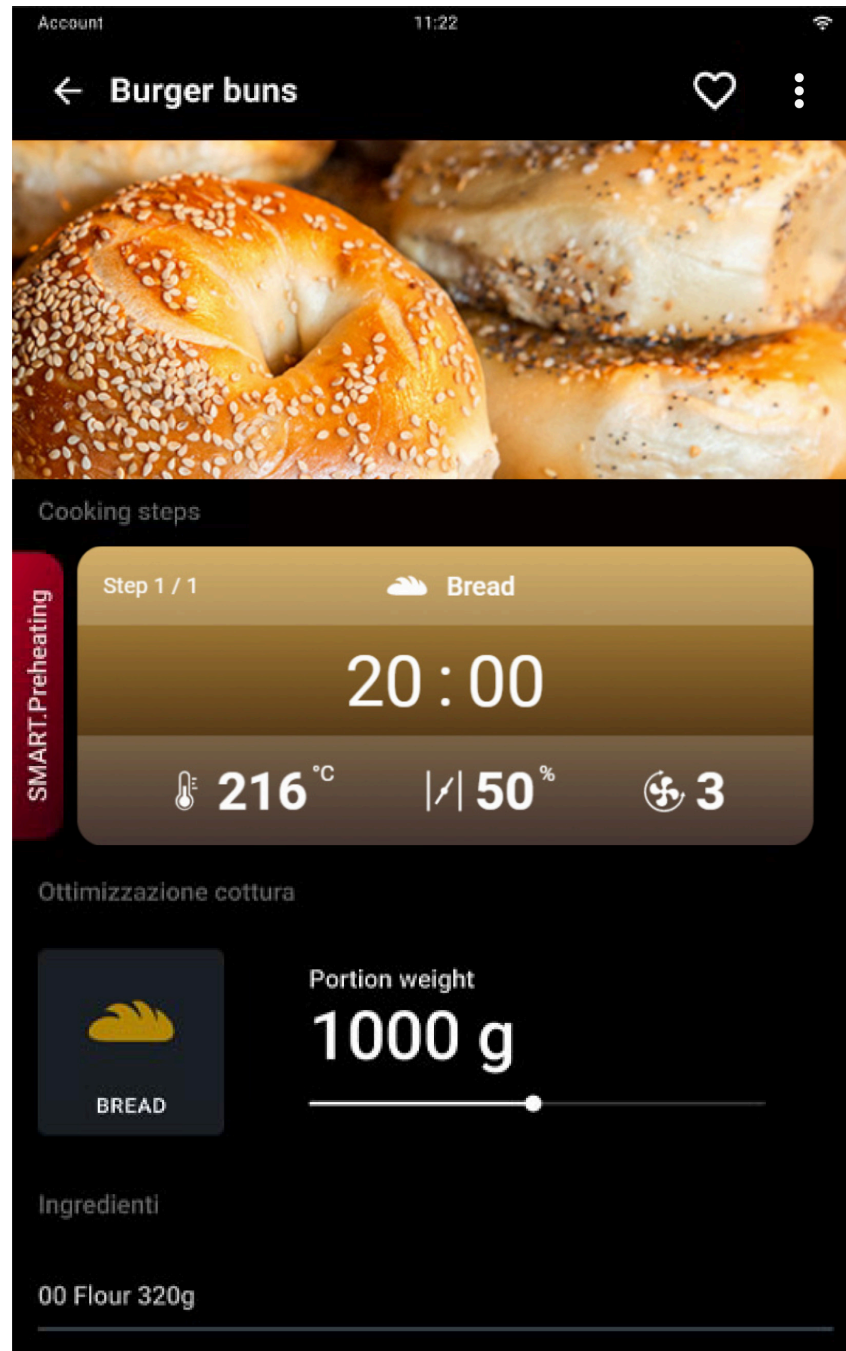

A page summarising the recipe's cooking parameters appears.



**AZ** Use the filters (e.g. alphabetical order, "favourite" recipes, etc.) to make it easier to search for the recipe you want.

---

# Recipe options

From the recipe card you can mark the recipe as a **favourite** by tapping the icon  . By tapping the **drop-down menu**  you can:

- **edit** the recipe's parameters (e.g. change the photo associated with it or the ingredients list, change the cooking time or oven temperature, etc.); by scrolling through the card that appears to right or left you can add more cooking steps to the recipe or activate or deactivate SMART.Preheating.
- **copy** the recipe;
- **add it** to a group;
- **share it** with other users;
- **delete it** (irreversible).

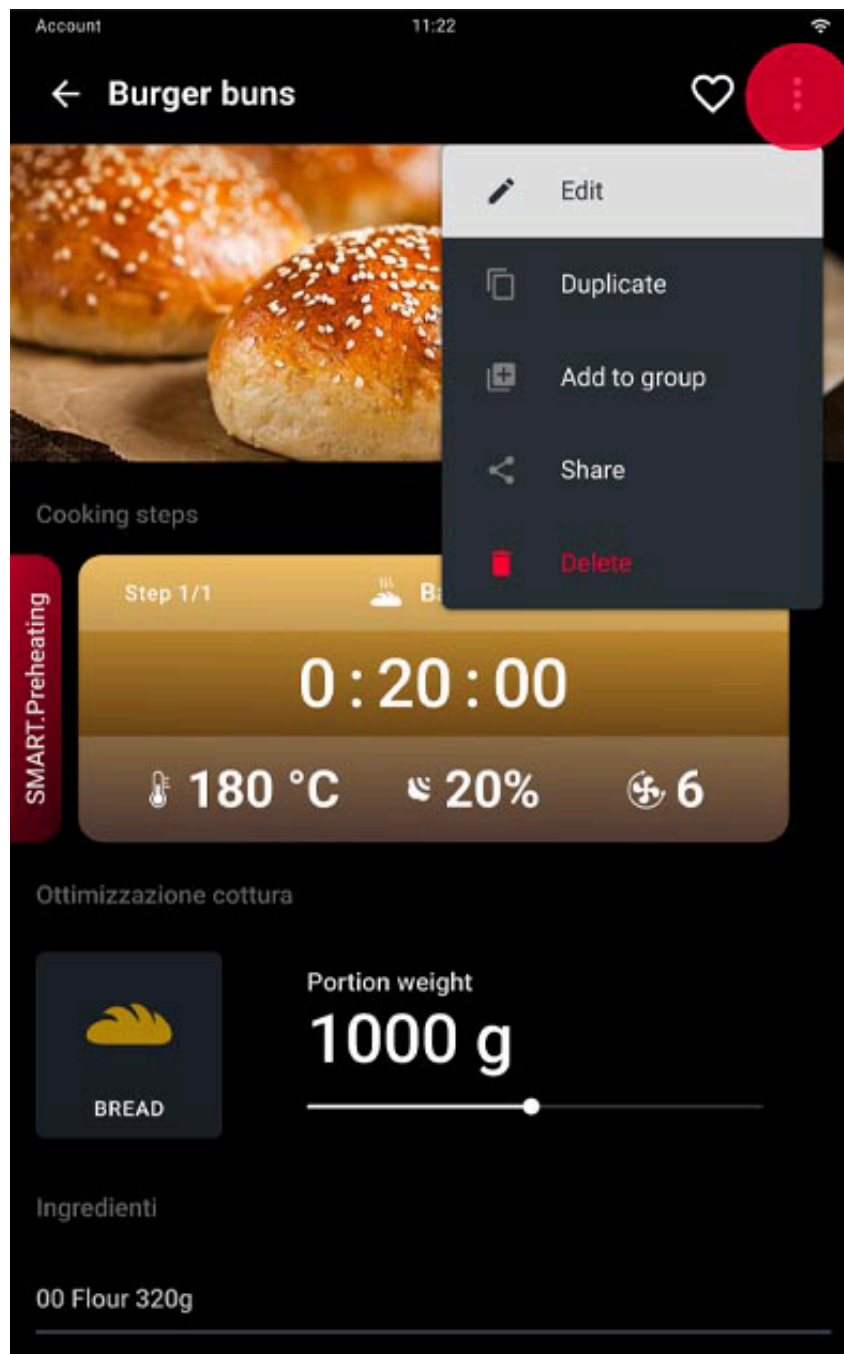

---

## Starting a recipe

Tap **START/STOP**  [to start the cooking cycle.](#)

---

# Creating a personal recipe

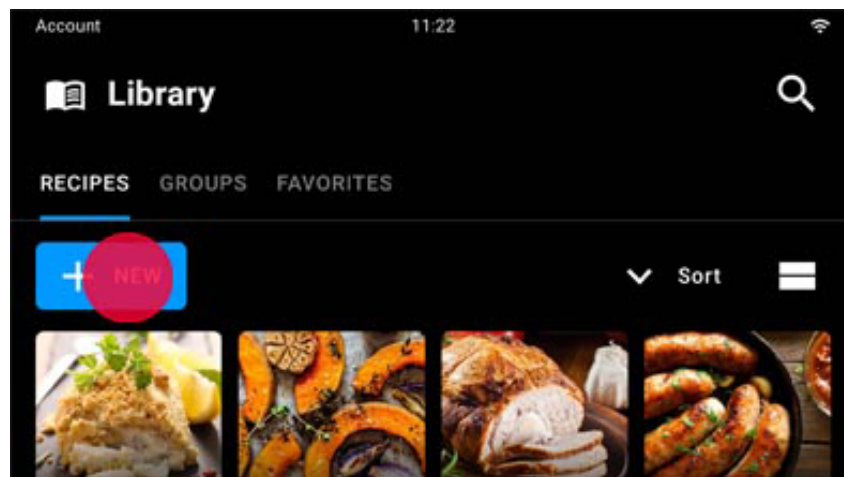

Tap the + NEW icon.



Set the recipe by adding:

- a **photo** to identify it (optional);
- its **name**;
- its cooking **parameters**; see an example of **setting parameters** here;
- the necessary **ingredients** (optional);
- the **description** of the various cooking steps (optional).

Save the settings with **SAVE**.

From the recipe card you can mark the recipe as a **favourite** by tapping the  icon or, by tapping the **drop-down menu** , as edited, copied, added to a group, shared with other users or deleted.

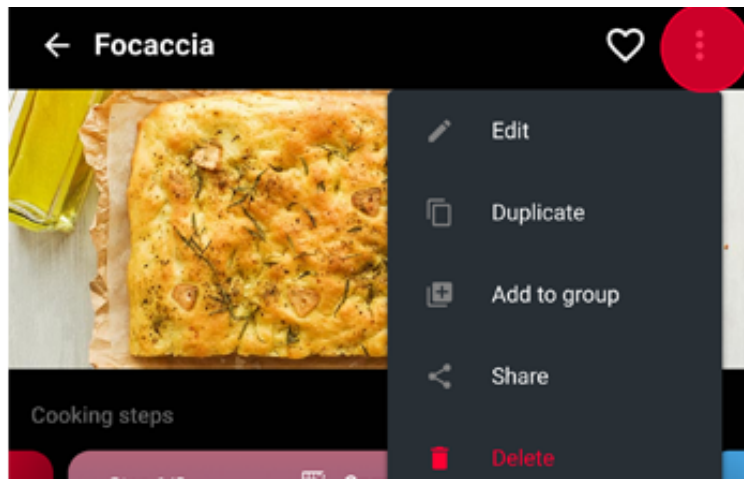

## Apps



# Chefunox-Speedunox

- [Browsing and selecting a recipe](#)
- [Recipe options](#)
- [Starting a recipe](#)

---

Chefunox - Speedunox allow you to use the recipes created and tested by the UNOX chefs to achieve excellent cooking results.

---

# Browsing and selecting a recipe

To select a recipe tap its icon. To make it easier to search, the recipes are divided up by food (e.g. poultry) or by type of cooking (e.g. COMBI).



To achieve customised cooking cycles, optimised for the food to be cooked, depending on the chosen recipe, you can edit the preset parameters as you wish by changing, for example, the **thickness** of the food to be cooked, its **weight**, the **external browning**, etc.

Whenever any parameter is changed use the + SAVE PRESET PARAMETERS button.

By tapping the button the parameters entered are permanently stored for future uses of the recipe.

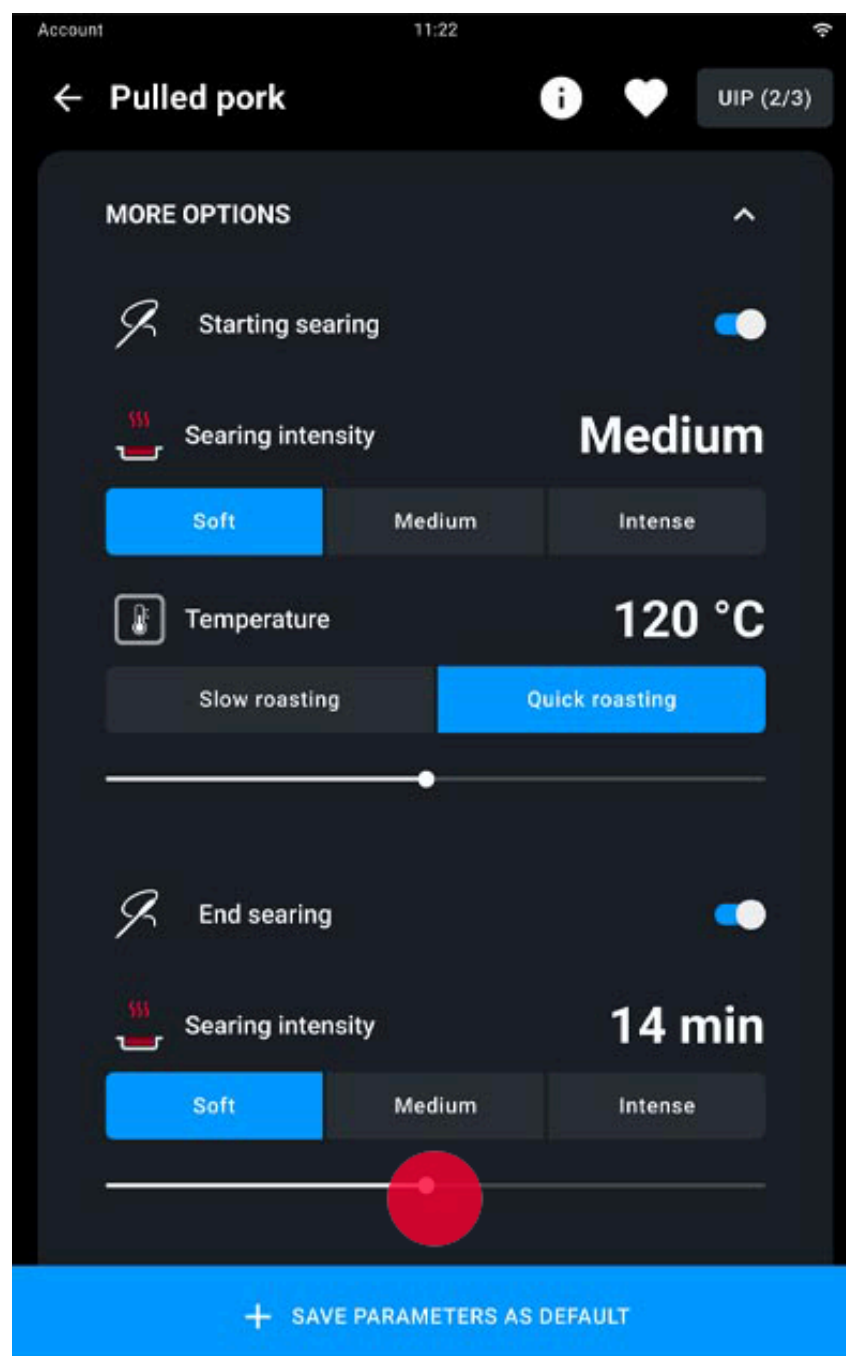

# Recipe options

From the recipe card you can:

- mark the recipe as a **favourite** by tapping the  icon
- change SMART.Preheating to manual preheating (not recommended), see how to deactivate [SMART.Preheating](#) here;
- activate or deactivate UIP technologies, see how to activate or deactivate [Unox Intelligence Performance](#) technologies here.

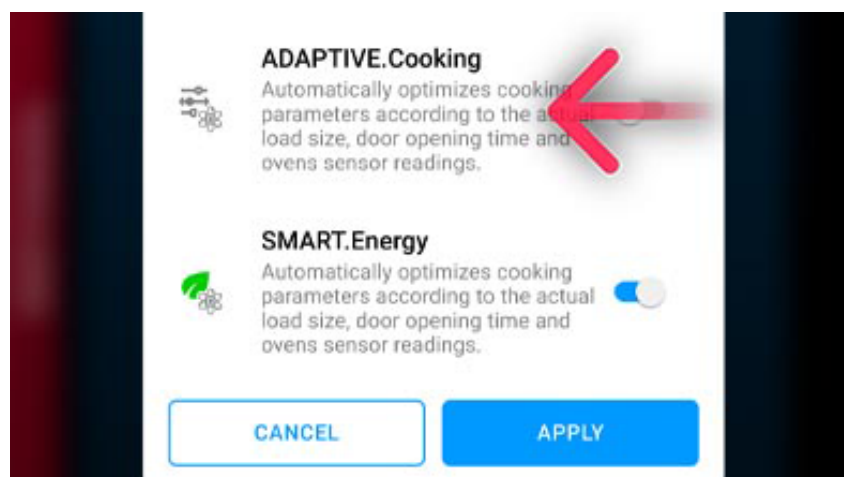

---

## Starting a recipe

Tap start/stop  [to start the cooking cycle.](#)

---

## Apps



# MULTI.Time

- [Browsing and selecting a program](#)
- [Setting a climate set](#)
- [Starting a cooking cycle](#)
- [During cooking: setting the timers](#)
- [Cooking cycle in progress](#)
- [Ending a cooking cycle](#)
- [Cooking summary](#)

---

MULTI.Time allows you to cook at the same time foods that need different cooking times under equal conditions (temperature, humidity, etc.).

If you use this app, the oven maintains the temperature and humidity you have set for an indefinite period (continuous cycle). In addition, you are able to set up to 10 timers that will alert you when the relevant tray is ready.

---

# Browsing and selecting a program

To start or create a multitime cooking cycle, you must select either:

- a preset program with **pre-filled start** (e.g. COMBI); cooking settings preset by UNOX based on the type of cooking chosen will be suggested; these parameters, preset by UNOX, can be edited based on your requirements. See how to [edit a UNOX preset program](#) here.
- a **Manual** preset program, fully customisable, that sets no limits to parameters. See how to create a personal preset program for future use here.

To select the preset program you want tap its name.

# Cooking Set

UIP (2/3)



Step 1/1



9 59 59  
**0:00:00**  
1 01 01



PRESET RECENTS PERSONALS

SMART.Preheating

New Step

Manual

Steam

Grilling

**Combi bake**

Brasing

Sous vide

Dehydrating

Frying and panfrying

Regeneration

Bake

Smocking

Roasting

# Setting a climate set

After selecting the preset cooking program, if you wish, you can edit the preset parameters to suit your needs.

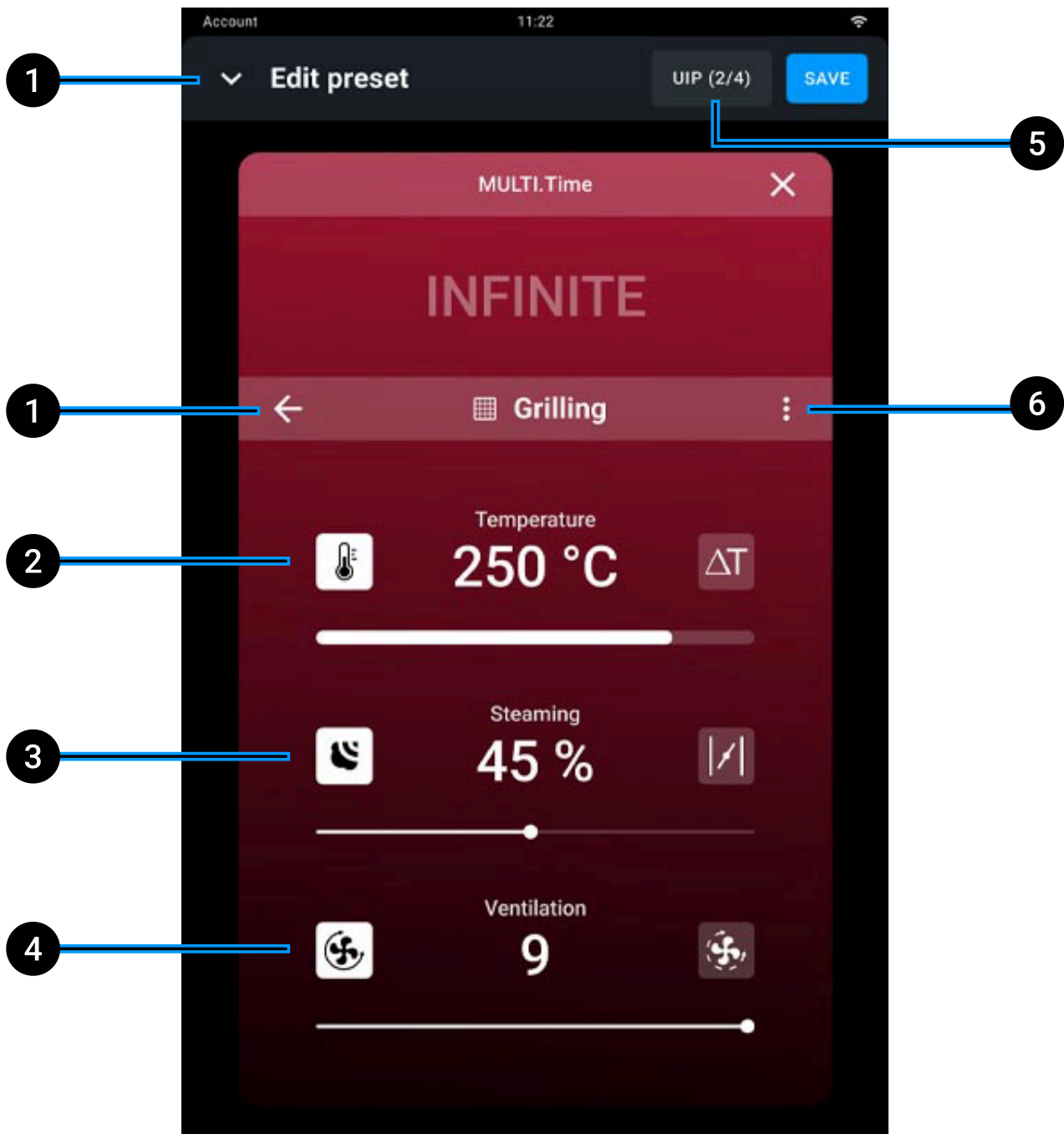

- 1 **back**: you can go back to the **choice of preset program** to select another one;
  - 2 **edit cooking temperature** from 30 to 300° C. For particularly delicate cooking cycles you can use the Delta T function, from 0 to 120° C (if available). In this case you must use the core probe, inserting it into the heart of the food. By definition, Delta T maintains a constant temperature difference between the temperature in the cavity and the probe temperature, using the formula: Cavity temperature minus core probe temperature;
  - 3 **edit steam release** STEAM.Maxi or removal DRY.Maxi;
  - 4 **edit speed of fans** in standard or pulse modes. If the fans are in pulse mode, they turn off when the oven reaches the temperature set;
  - 5 **UIP**: you can edit activation of the [Unox Intelligence Performance](#) technology (not recommended);
  - 6 **Save/delete** the preset program set.
-

## Confirm the values entered

The save button confirms the values entered.

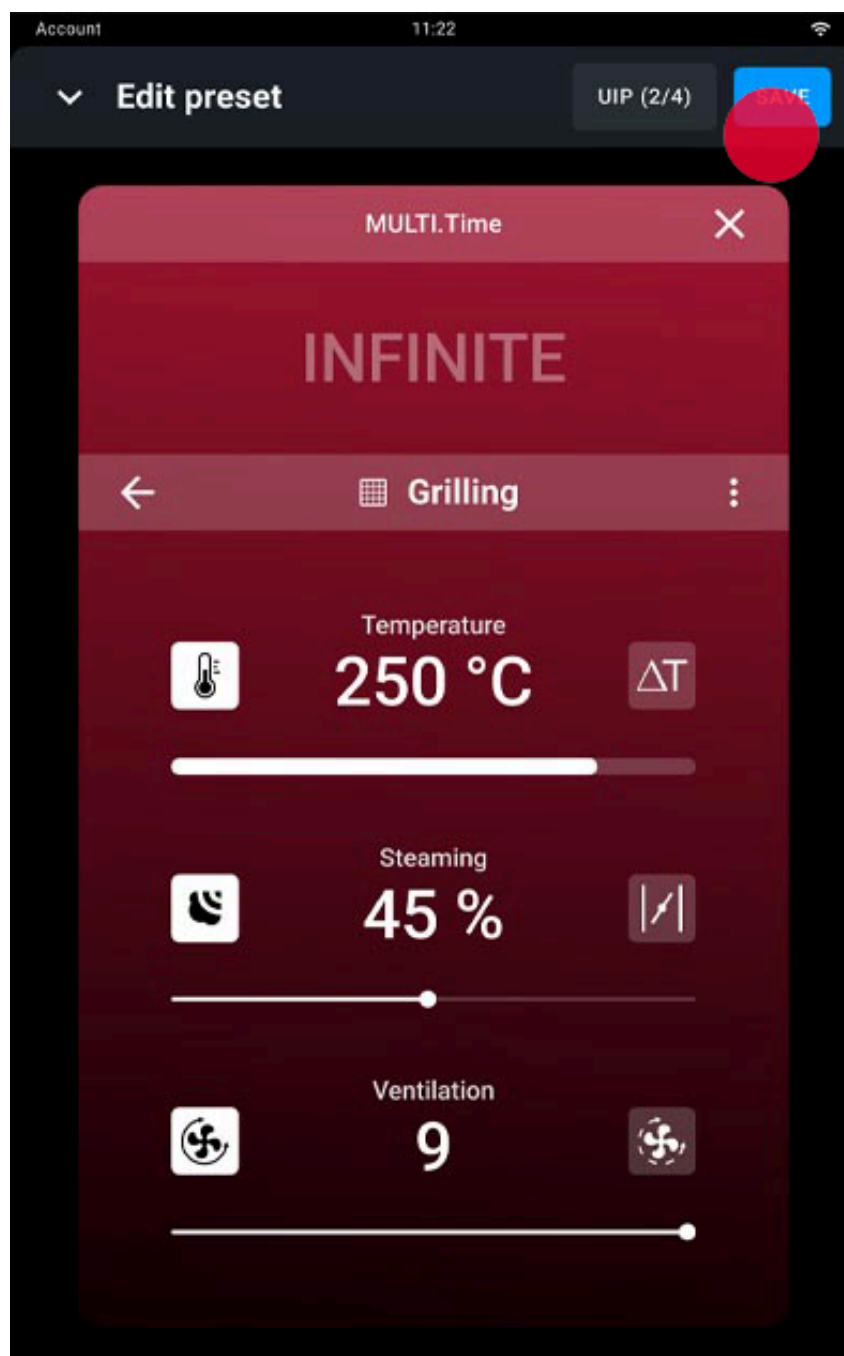

# Starting a cooking cycle

Tap **START/STOP** START  
STOP to start the cooking cycle: a manual or Smart.Preheating phase begins, depending on what you have previously set.

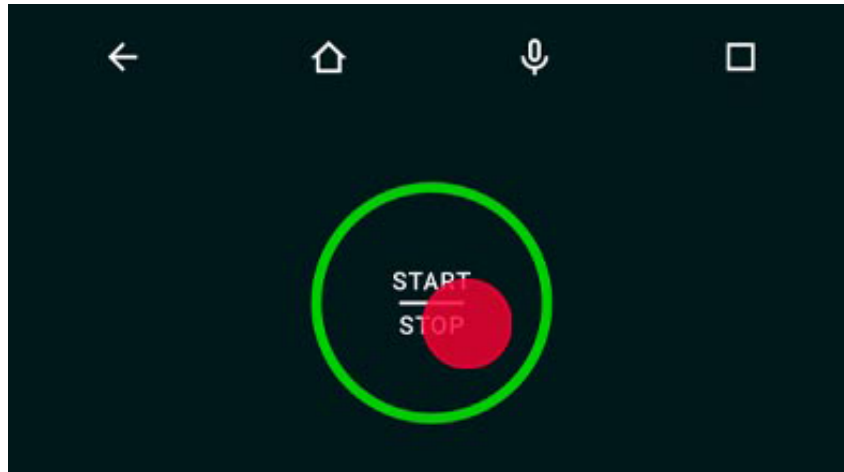

To stop preheating that's in progress at any time, whether manual or SMART.Preheating, press the skip button and confirm.



See further information about [preheating](#) here.

When preheating is completed or after it has been stopped prematurely, a screen will remind you to put the food into the oven.

---

# During cooking: setting the timers

We recommend associating timer 1 with the tray at the top of the oven, timer 2 with the tray below and so on. This will help you to remember which tray needs to be taken out when a timer runs out. The card also offers the following buttons:

- tap the  button to display 5 timers
- tap the  button to display 10 timers
- tap the  button to activate or deactivate the technologies, see information about [Unox Intelligence Performance](#) here.

---

## Setting timers using a compatible recipe

Tap the + ADD PROGRAM icon.

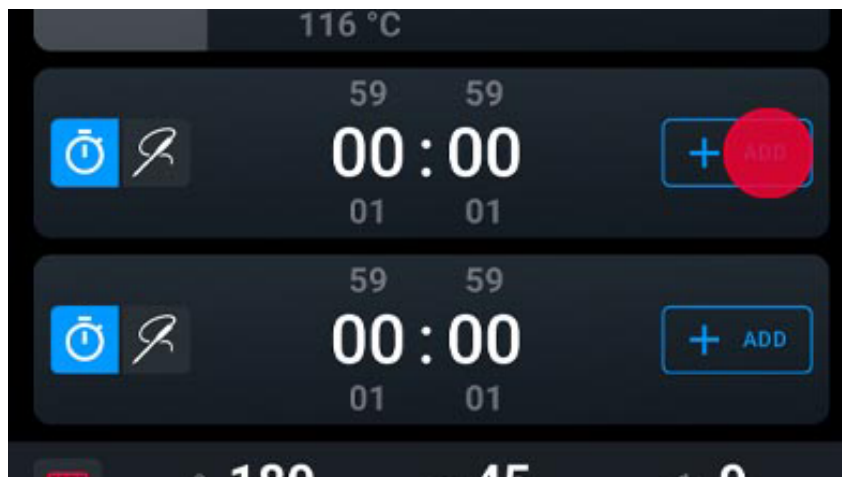

You will be offered all the recipes that are compatible with the climate set that you have already chosen, divided into types (use the filters to make searching easier); tap the one you want to assign to the timer.

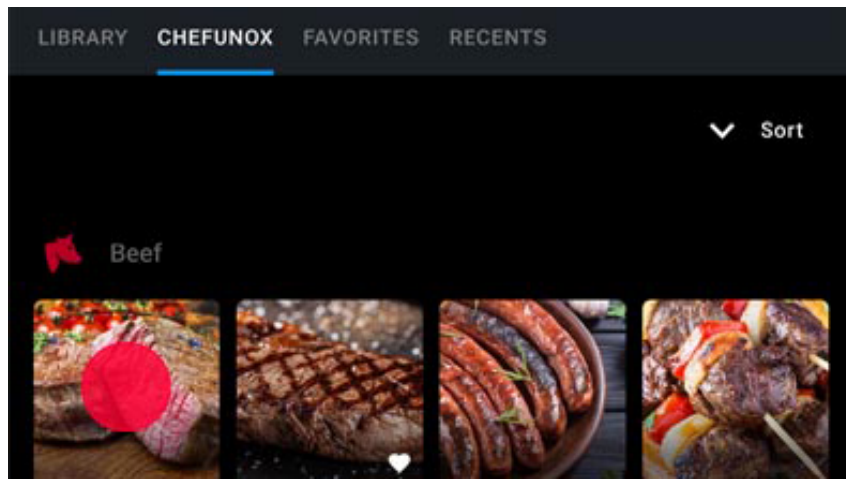

Enter the settings required to adapt the recipe to your needs and confirm with ADD.

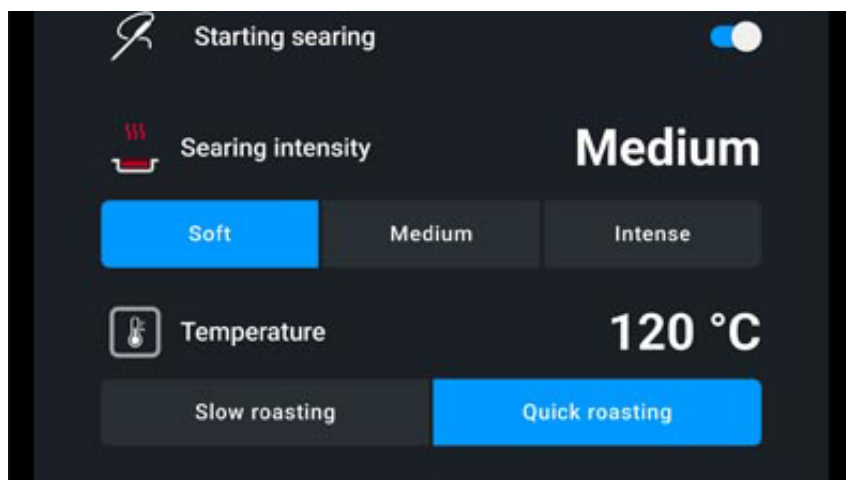

# Setting timers manually

Enter the duration of the timers that you need (up to a maximum of 5) from 0 mins to 9 hrs 59 mins 59 secs.

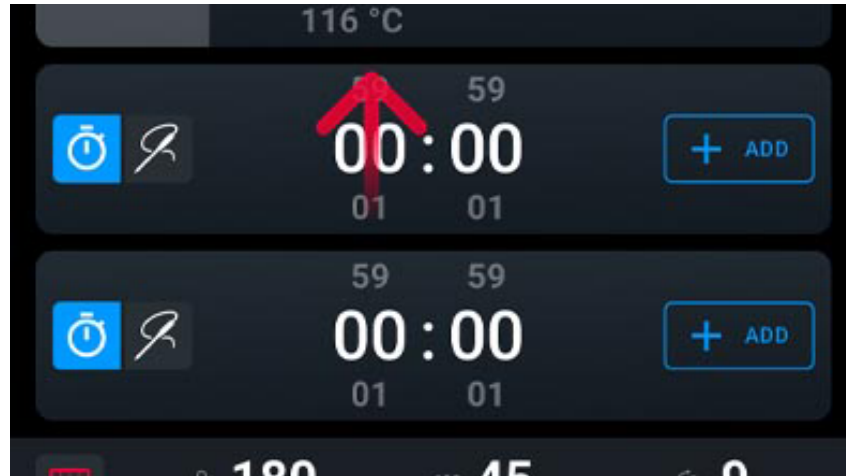

# Cooking cycle in progress

The picture shows a MULTI.Time cooking cycle that's in progress.

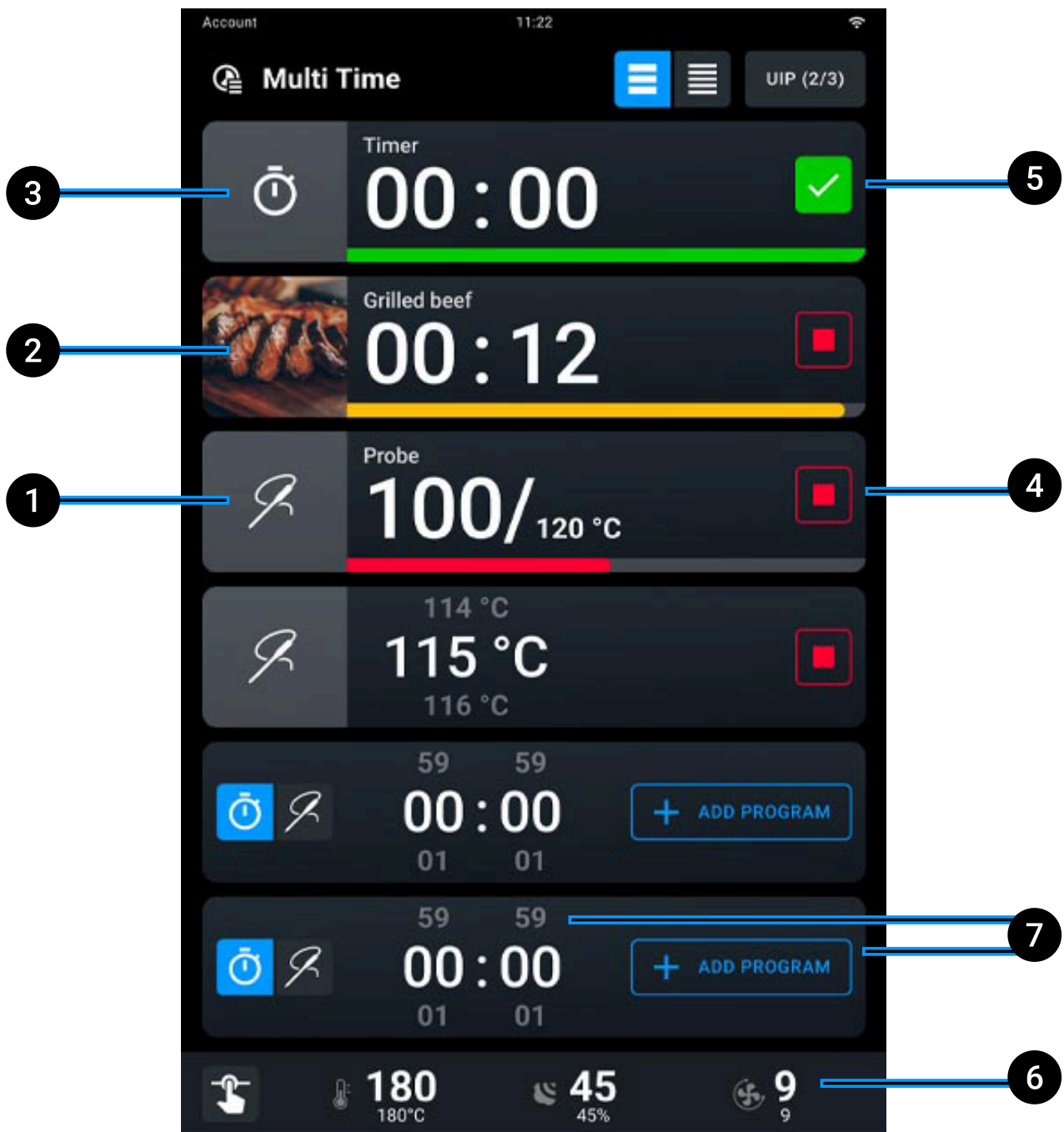

- 1 **timer not expired**: end of cooking > 15 seconds;
  - 2 **timer not expired**: end of cooking < 15 seconds;
  - 3 **timer expired**: end of cooking < 5 seconds;
  - 4 **cancel** the timer;
  - 5 **confirm** the expired timer and go back to the settings;
  - 6 enable **variations** to the climate set in progress in the absence of active timers; see how [to edit climate set](#) here.
  - 7 **set a new timer**, by entering a duration (hours : minutes) or adding an already existing program.
-

# Ending a cooking cycle

By using this function, the oven maintains the set temperature and humidity indefinitely (continuous cycle).

When the time set by a timer runs out, a buzzer will tell you that the relevant tray is ready and you can take it out.

If you tap and hold down the  $\frac{\text{START}}{\text{STOP}}$  button the cooking cycle in progress stops.

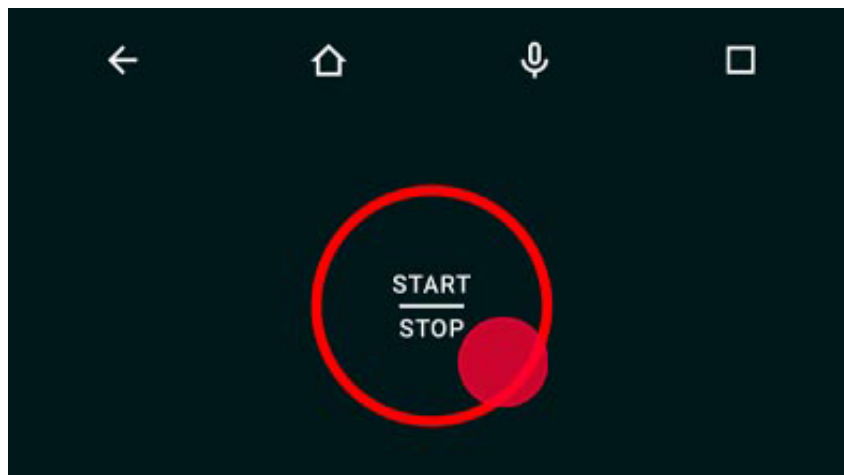

# Cooking summary

At the end of the cooking cycle a summary card will appear and a buzzer will sound that can be silenced by tapping the STOP BUZZER button.

Then a card appears summarising consumption.

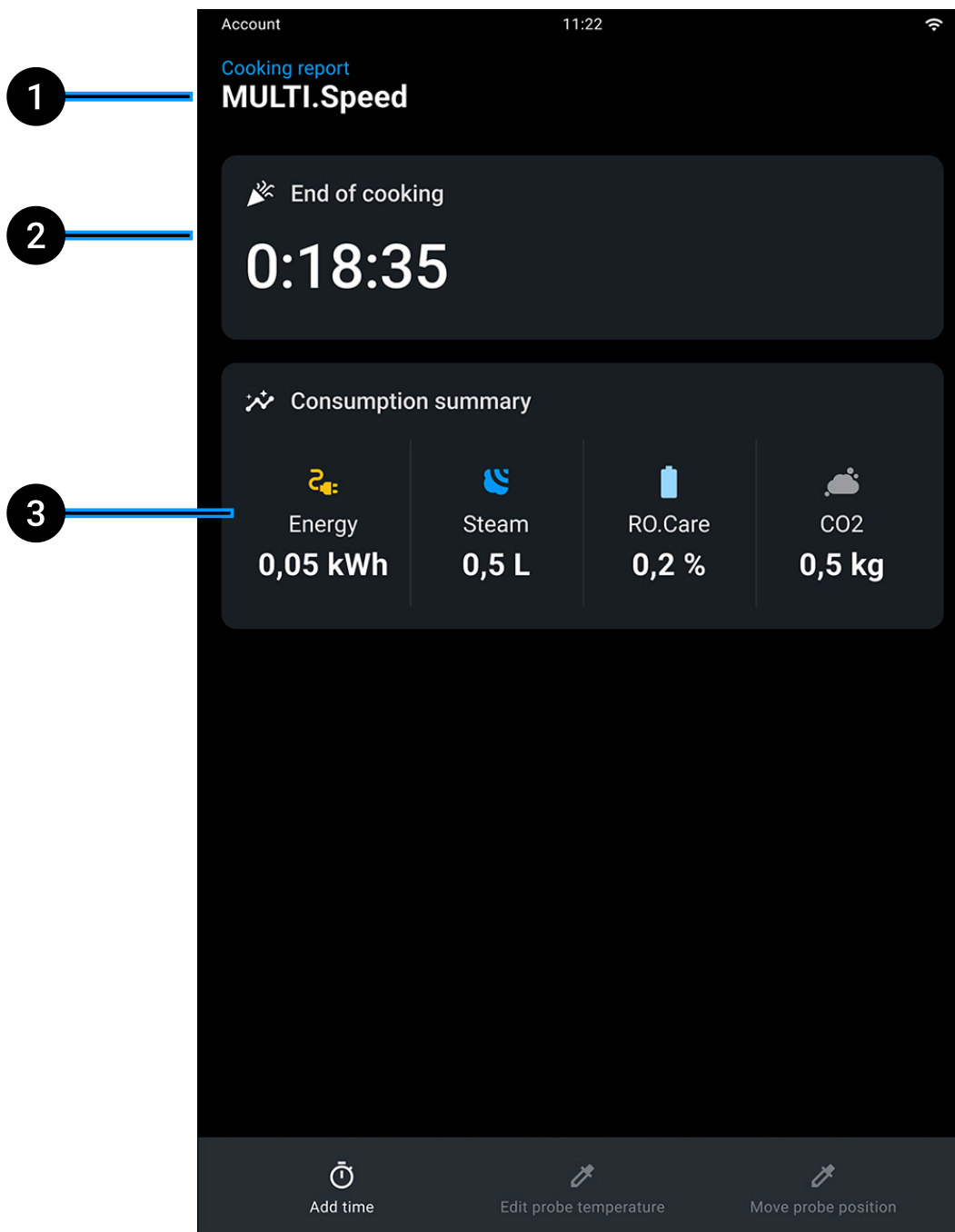

- 1 **name** of the recipe in progress;
  - 2 **duration** of cooking cycle just ended;
  - 3 **consumption summary** (electricity, steam, CO<sub>2</sub>).
-

## Apps



# MULTI.Speed

- [Inserting the SPEED.Plate tray](#)
- [Setting a climate set](#)
- [Setting the timers](#)
- [Cooking cycle in progress](#)
- [Ending a cooking cycle](#)
- [Cooking summary](#)

---

MULTI.Speed allows you to cook products that need different cooking times at the same time.

By using this app, you are able to set up to 4 timers that will alert you when the relevant tray is ready.

---

# Inserting the SPEED.Plate tray

MULTI.Speed cooking cycles are carried out using the SPEED.Plate tray supplied with the appliance. A notification will remind you to use this accessory.

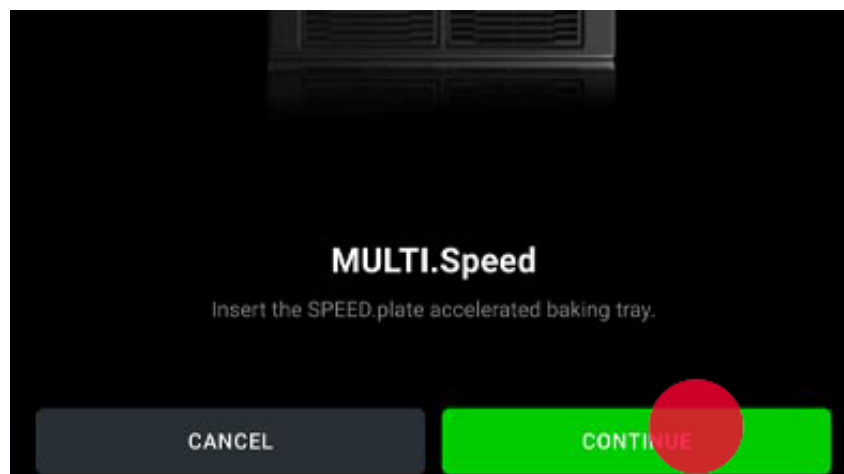

After confirmation, a manual or Smart.Preheating phase begins, depending on what you have previously set.

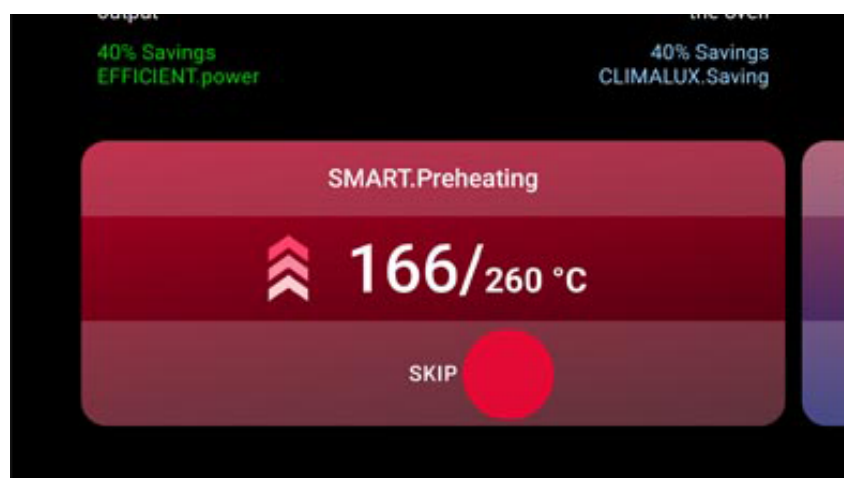

To stop preheating that's in progress at any time, whether manual or SMART.Preheating, press the skip button and confirm.

See further information about [preheating](#) here.

---

# Setting a climate set

Set the climate set that most suits the food you want to cook.

## Landing page display and explanation

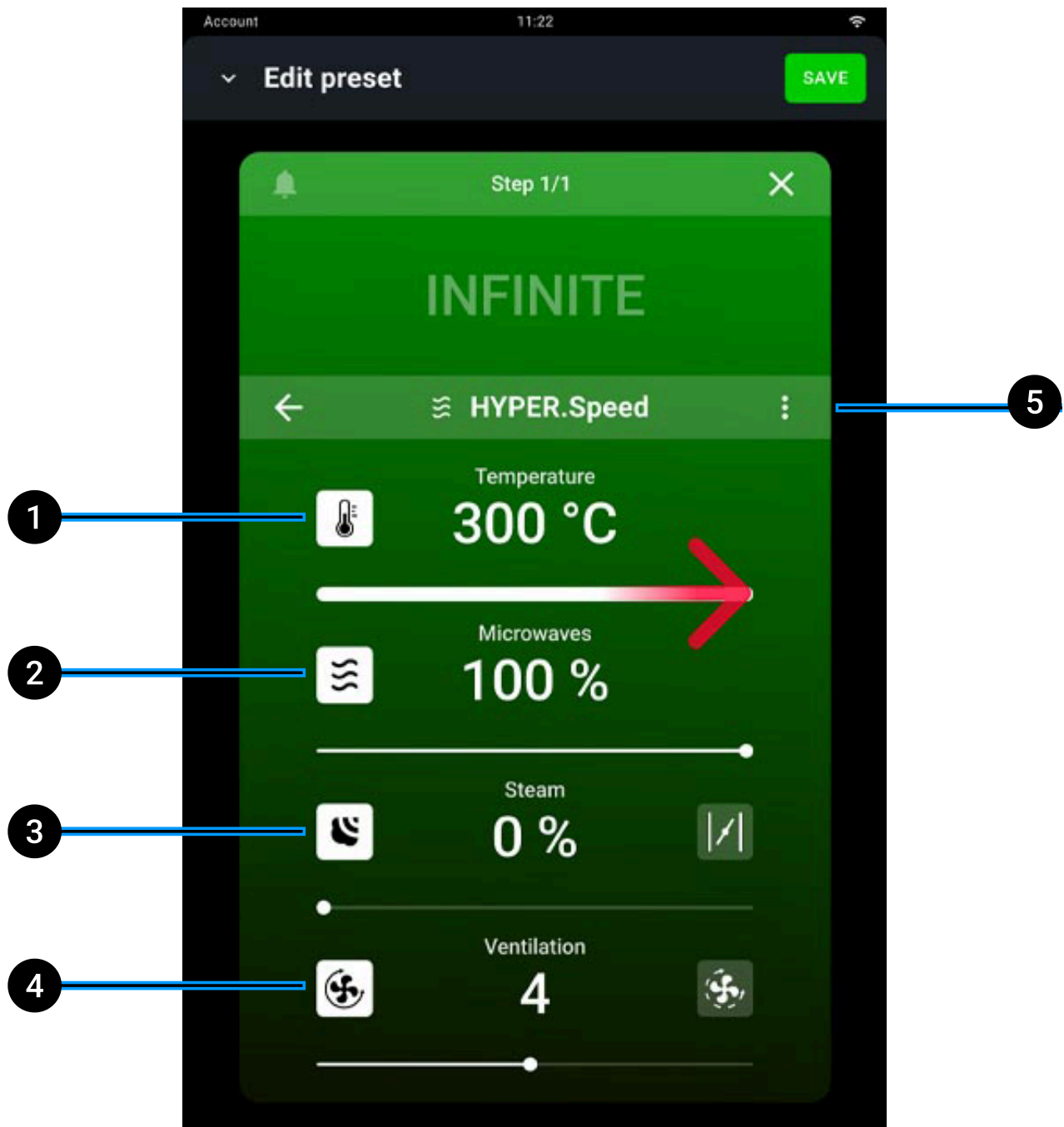

- 1 edit cooking temperature** from 30 to 260° C. For particularly delicate cooking cycles you can use the Delta T function, from 0 to 120° C (if available). In this case you must use the core probe, inserting it into the heart of the food. By definition, Delta T maintains a constant temperature difference between the temperature in the cavity and the probe temperature, using the formula: Cavity temperature minus core probe temperature;
  - 2 edit the microwave power;**
  - 3 edit steam release** STEAM.Maxi or removal DRY.Maxi;
  - 4 edit speed of fans** in standard or pulse modes. If the fans are in pulse mode, they turn off when the oven reaches the temperature set;
  - 5 save/delete** the climate set.
-

## Confirm the values entered

The SAVE button confirms the values entered.

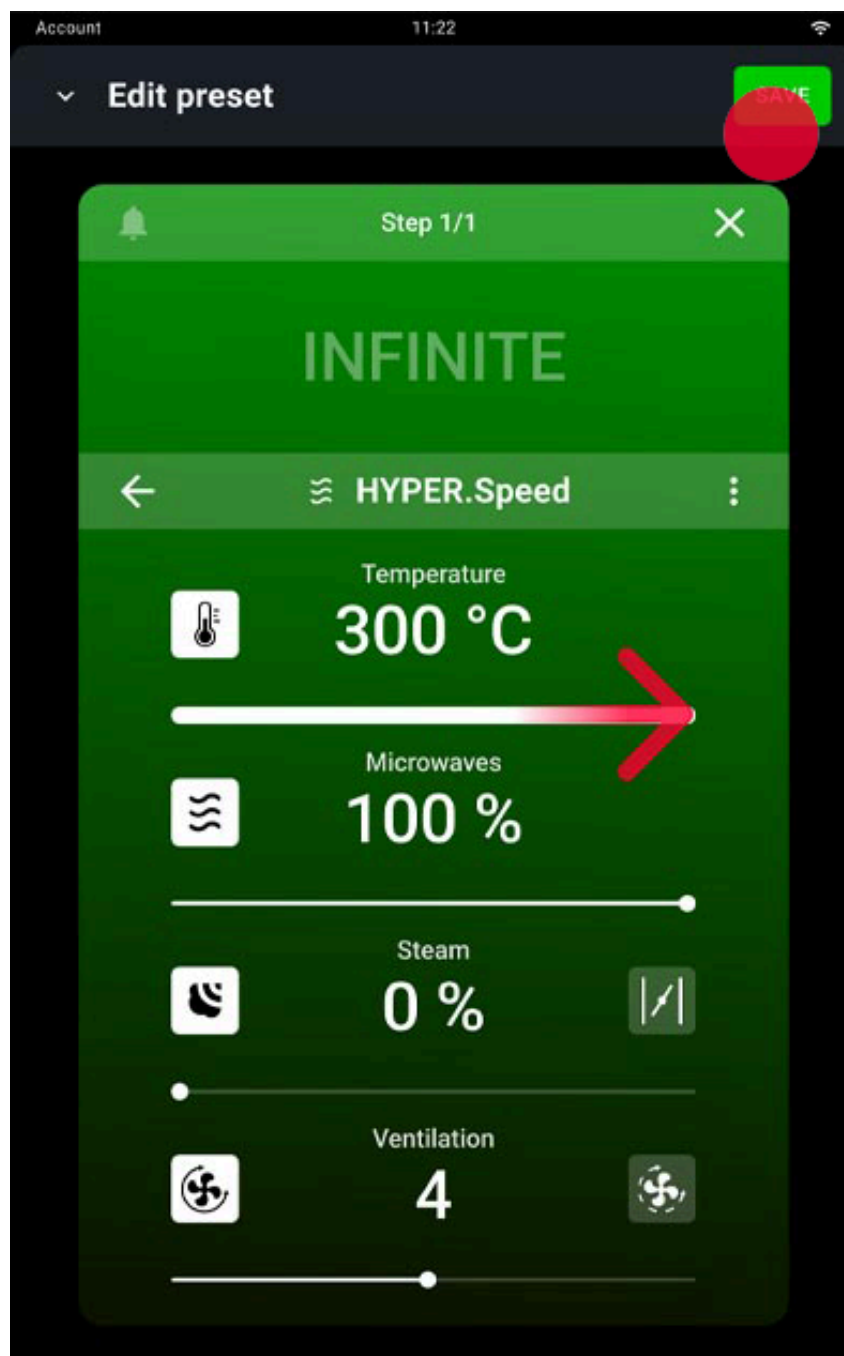

# Setting the timers

## Setting timers using a compatible recipe

Tap the + ADD PROGRAM icon.

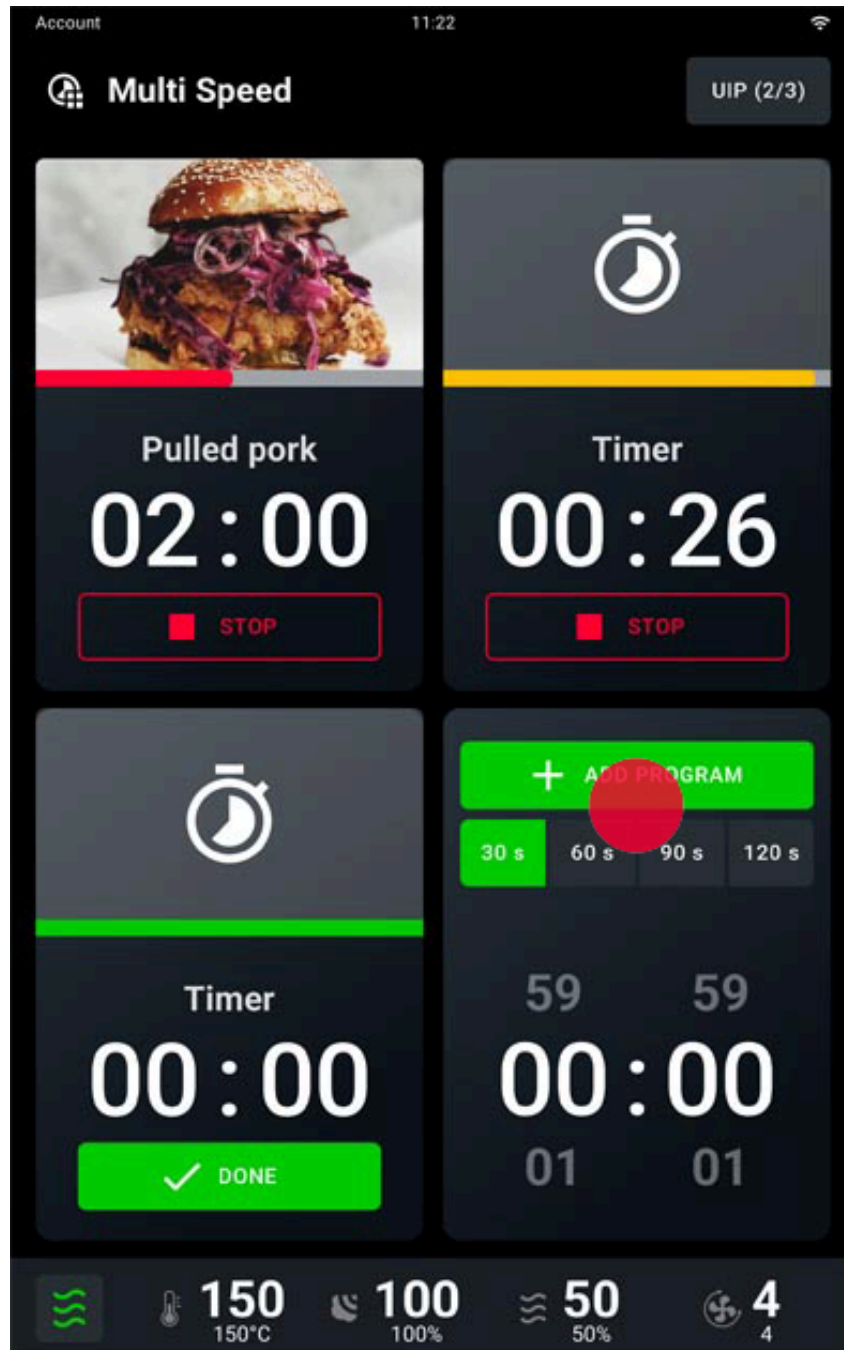

You will be offered recipes divided into types; tap the one you want to assign to the timer. Also indicate the **number of portions**.

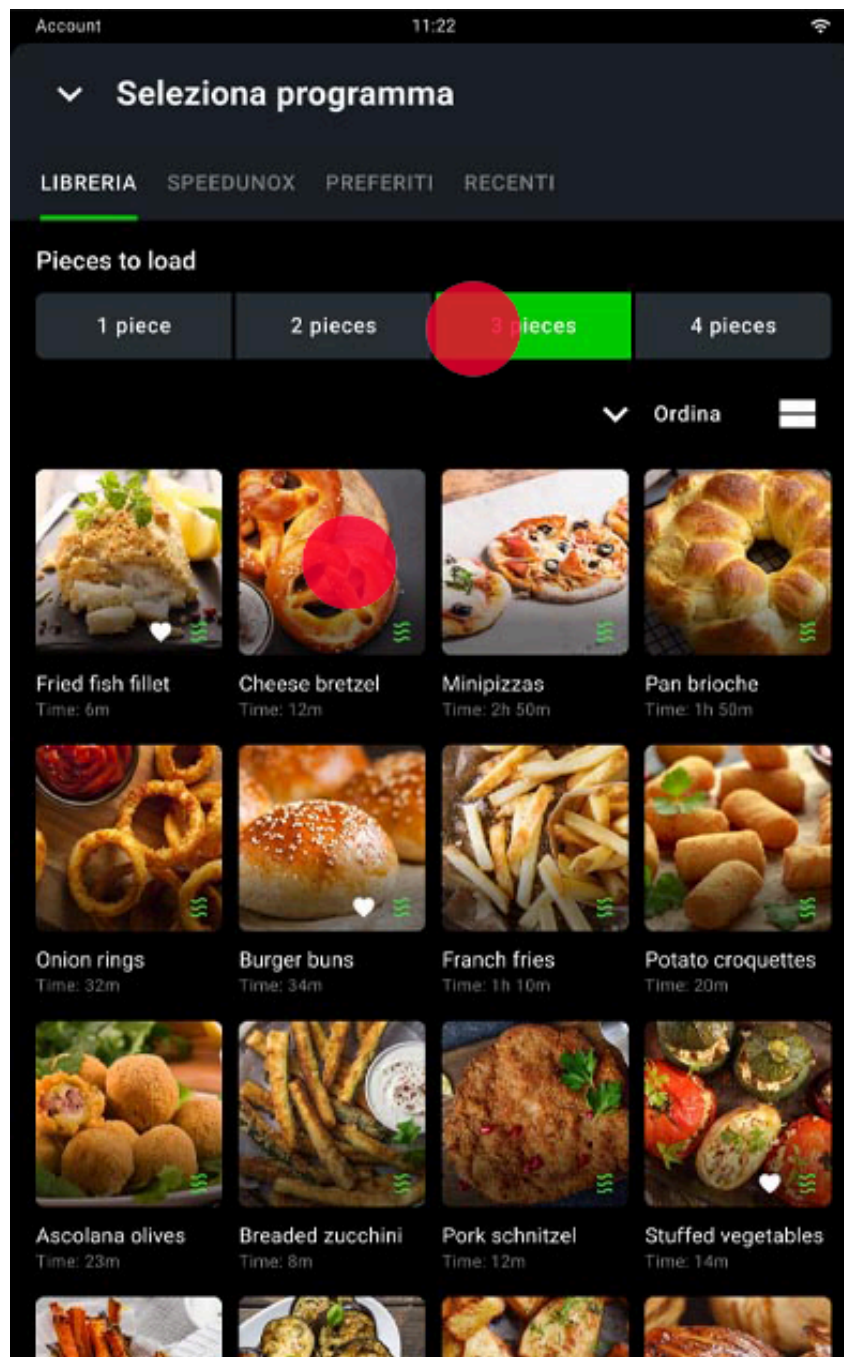

---

## Setting timers manually

You can set the timers by touching the preset times (30-60-90-120 seconds) or by manually setting the duration.

---

# Cooking cycle in progress

The picture shows a MULTI.Speed cooking cycle that's in progress.

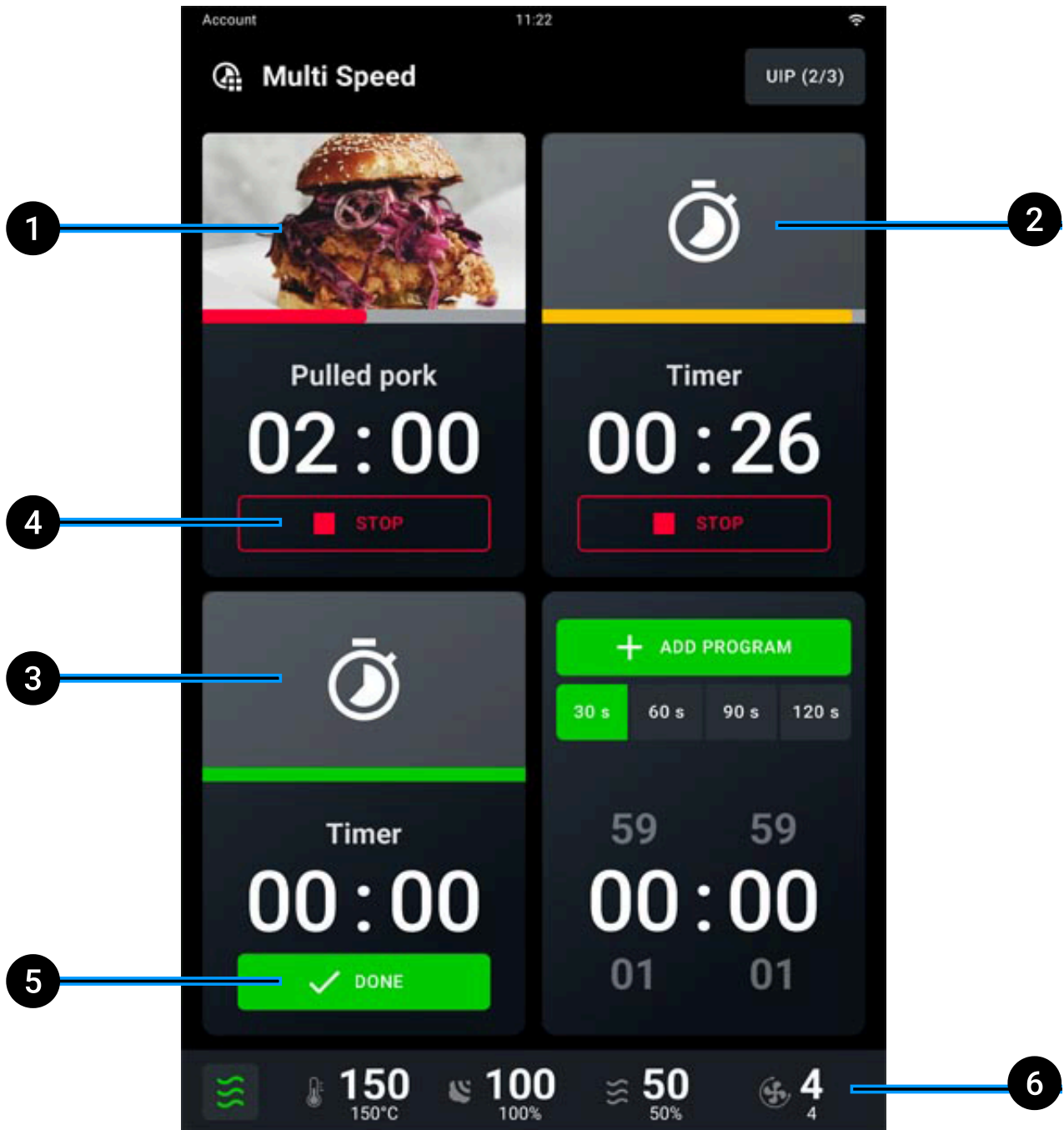

- 1 **timer not expired**: end of cooking > 15 seconds;
  - 2 **timer not expired**: end of cooking < 15 seconds;
  - 3 **timer expired**: end of cooking < 5 seconds;
  - 4 **cancel** the timer;
  - 5 **confirm** the expired timer and go back to the settings;
  - 6 enable **variations** to the climate set in progress in the absence of active timers; see how [to edit climate set](#) here.
- 

## Ending a cooking cycle

By using this function, the oven maintains the set temperature and humidity indefinitely (continuous cycle).

When the time set by a timer runs out, a buzzer will tell you that the relevant tray is ready and you can take it out.

If you tap and hold down the **START/STOP** button  $\frac{\text{START}}{\text{STOP}}$  the cooking cycle in progress stops.

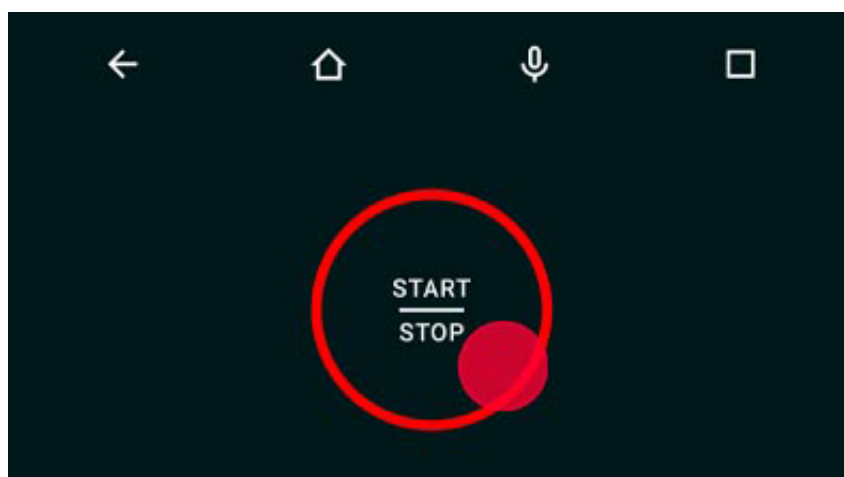

# Cooking summary

By using this function, the oven maintains the set temperature and humidity indefinitely (continuous cycle). Holding down the **START/STOP**  $\frac{\text{START}}{\text{STOP}}$  button pauses cooking; at the end of the cooking cycle a summary card will appear and a buzzer will sound that can be silenced by tapping the **STOP BUZZER** button. Then a card appears summarising consumption.

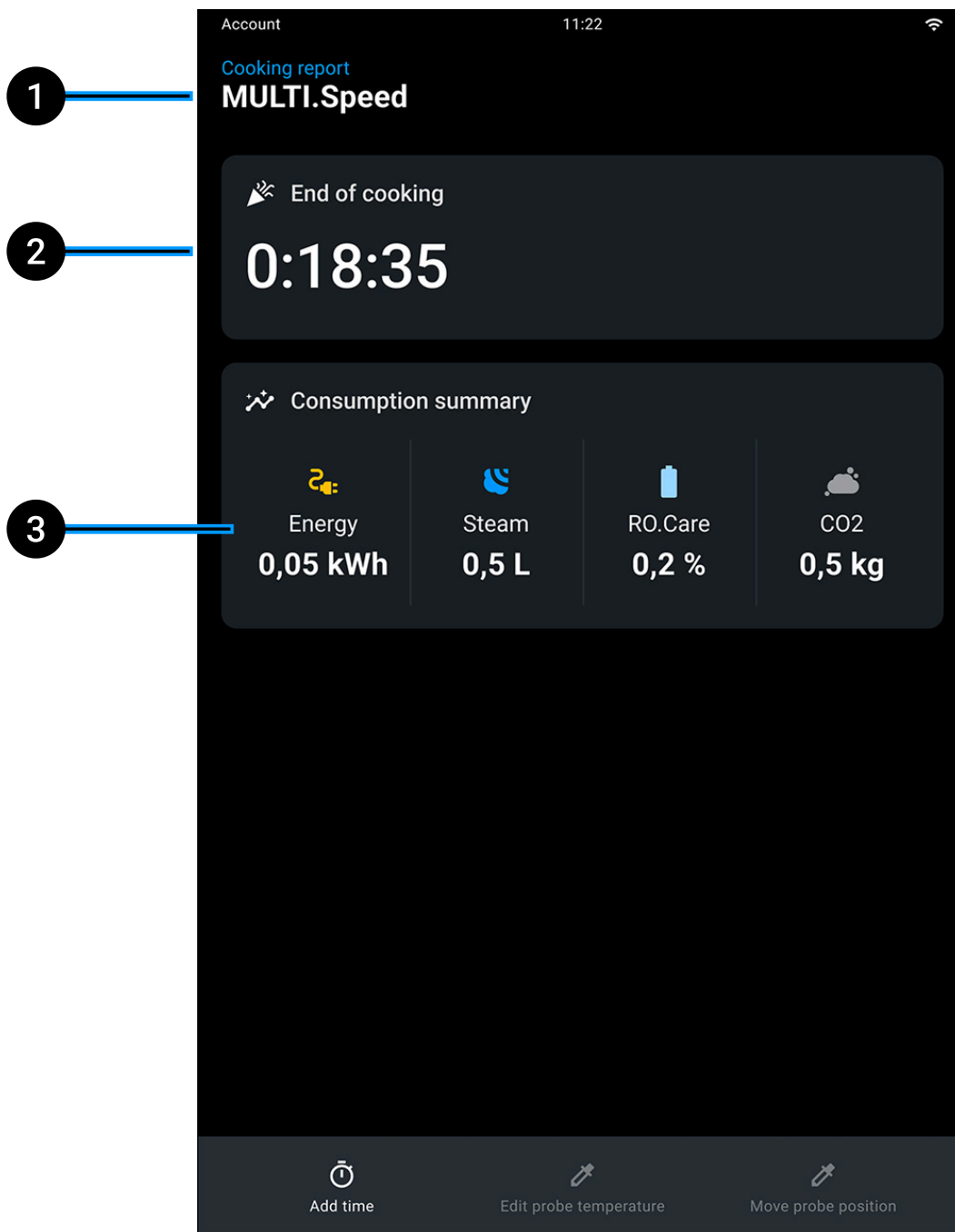

- 1 **name** of the recipe in progress
  - 2 **duration** of cooking cycle just ended;
  - 3 **consumption summary** (electricity, steam, CO<sub>2</sub>).
-

## Apps

# Washes



- see here [Safety precautions](#)
  - see here [Starting a wash](#)
  - see here [Cleaning in progress](#)
  - see here [Wash summary](#)
  - see here [Refilling Det&Rinse](#)
  - see here [Replacing the RO.Care filter](#)
-

Apps



# Data Driven Cooking

- [Detailed consumption screen](#)
  - [State of cleanliness of oven cavity](#)
  - [Cooking reports](#)
-

# DDC (Data Driven Cooking)

By using this app you can find out activity data and your oven's consumption. To display the whole card you have to drag it up or down.

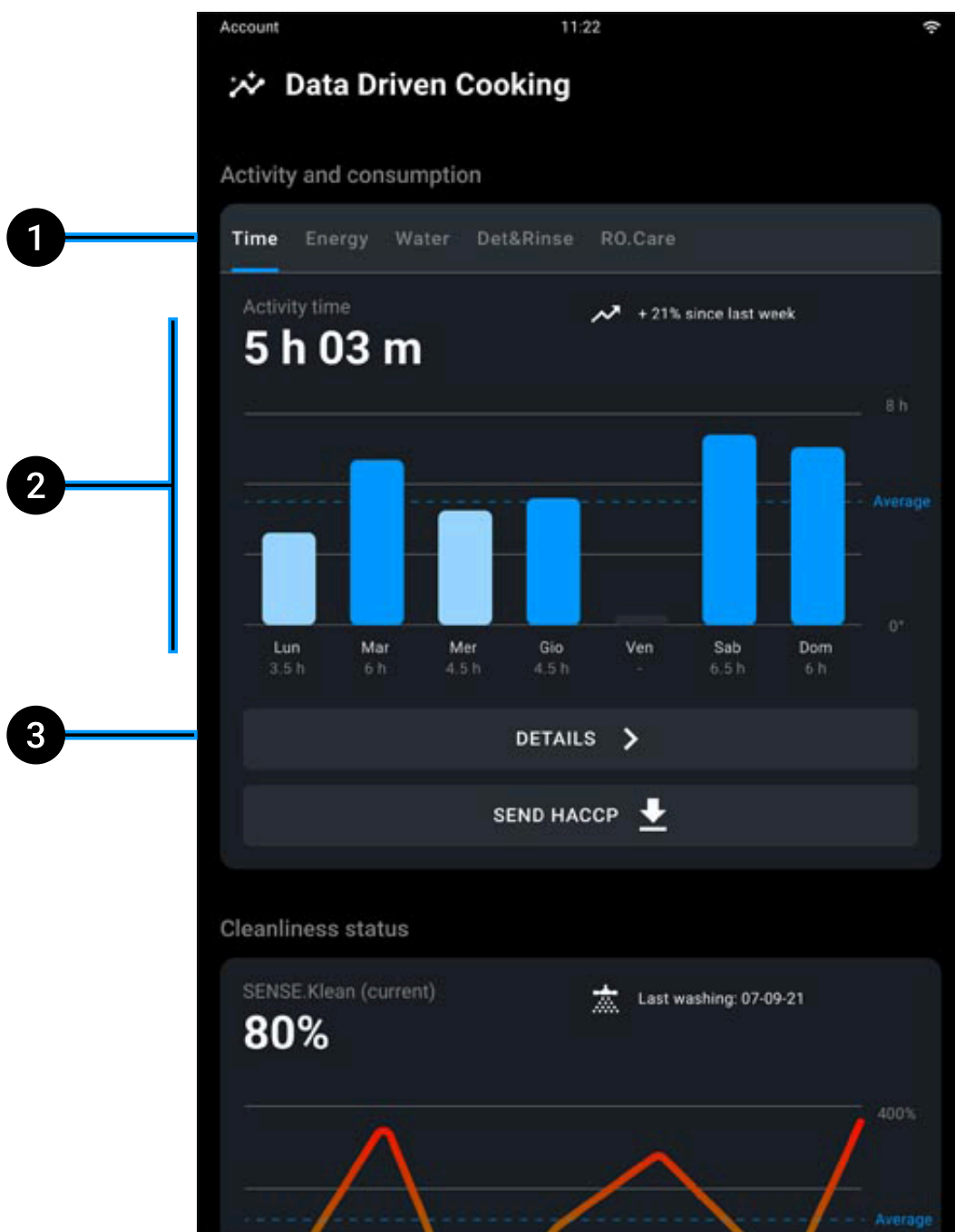

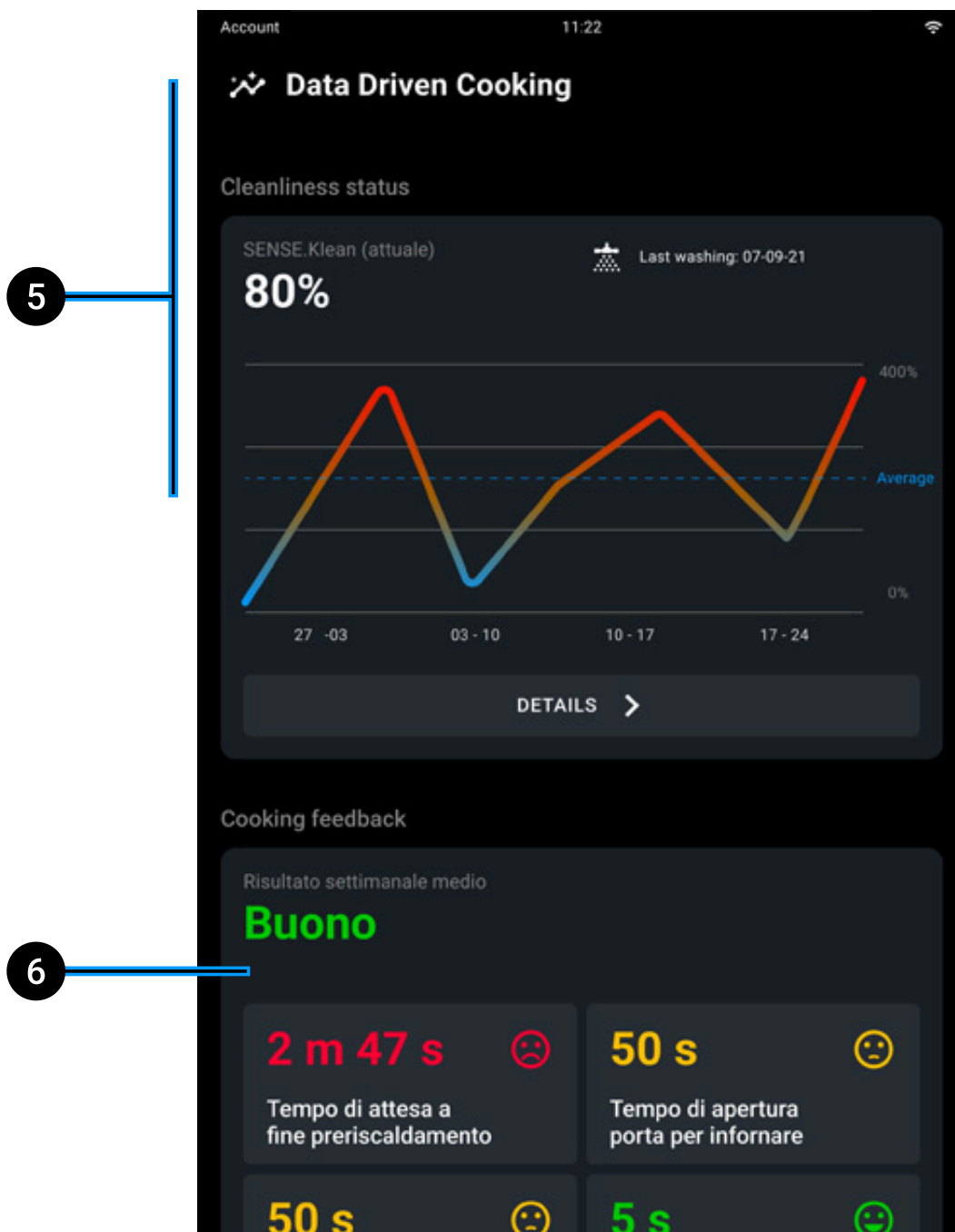

- 1 **select the data of interest** (time of use, consumption of electricity, water, [Det&Rinse™](#), [RO.Care](#));
- 2 **time of use of oven** in hours and minutes or a graphic representation;
- 3 [detailed consumption screen](#);

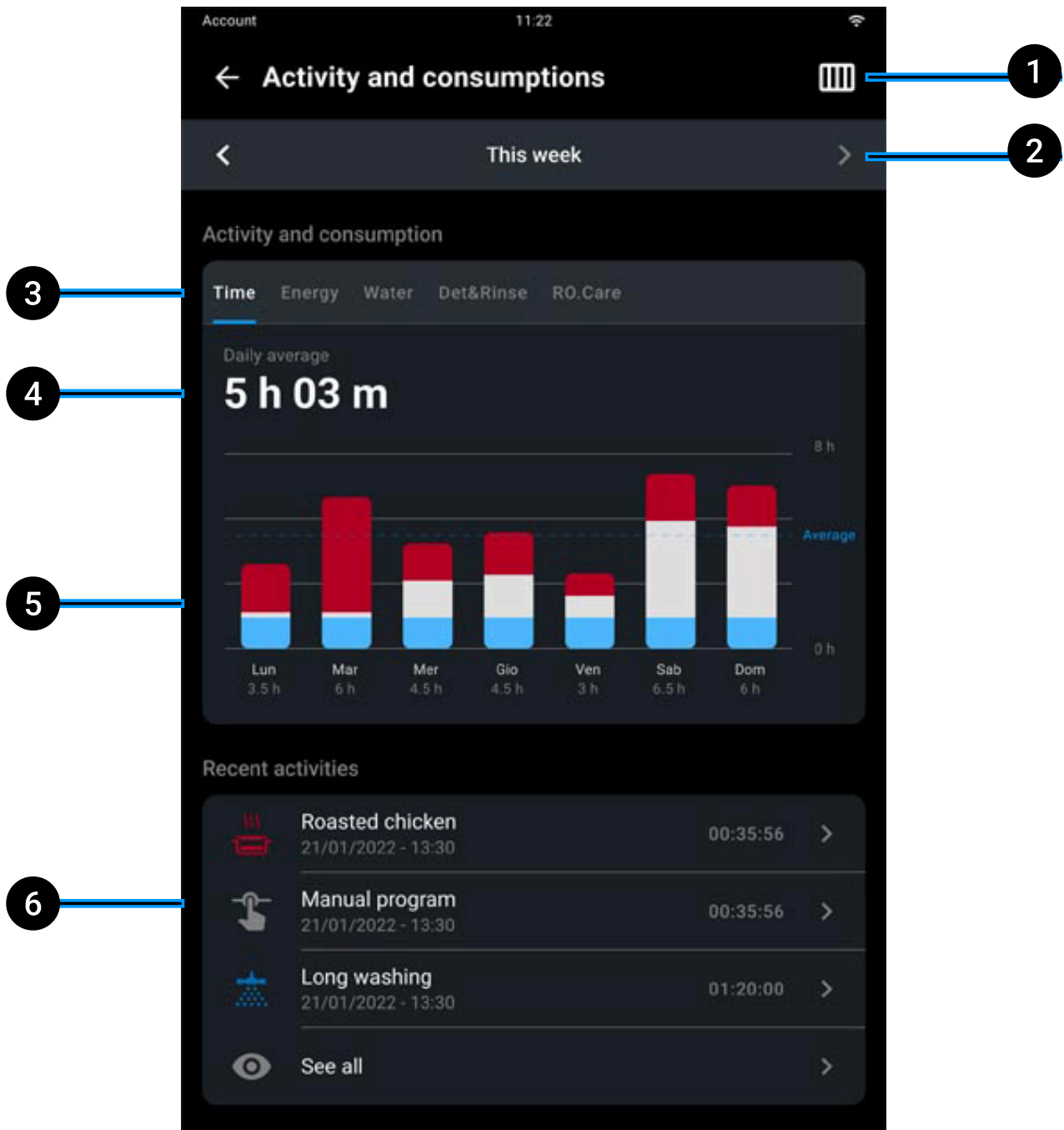

- 5 [cleanliness status](#) of oven cavity;
- 6 [cooking reports](#).

## Detailed consumption screen



- 1 **change the display** from weekly to monthly:
  -  weekly display
  -  monthly display
- 2 select the week or month of interest;
- 3 **select the data of interest** (time of use, consumption of electricity, water, [Det&Rinse™](#), [RO.Care](#));
- 4 average daily hours of use;
- 5 **graphic display of** hours of use subdivided into:
  - manual cooking
  - **cooking from saved program** ([Library](#) app or [Chefunox](#))
  - [washes](#)
- 6 **recent activity of oven:** if you tap one of the recent activities you will be able to see a report:
  - length of individual activity;
  - comparison of SPEED-X™ consumption with other non Energy.Star ovens;
  - graphic cooking performance with all program details;

If you tap see all you will be able to see the whole list of programs that made up the hours of use of the oven in the week or month concerned.

---

# State of cleanliness of oven cavity

See what the oven's state of cleanliness has been like in the last week or month. If you tap **DETAILS** you will see all the washes done and their details.

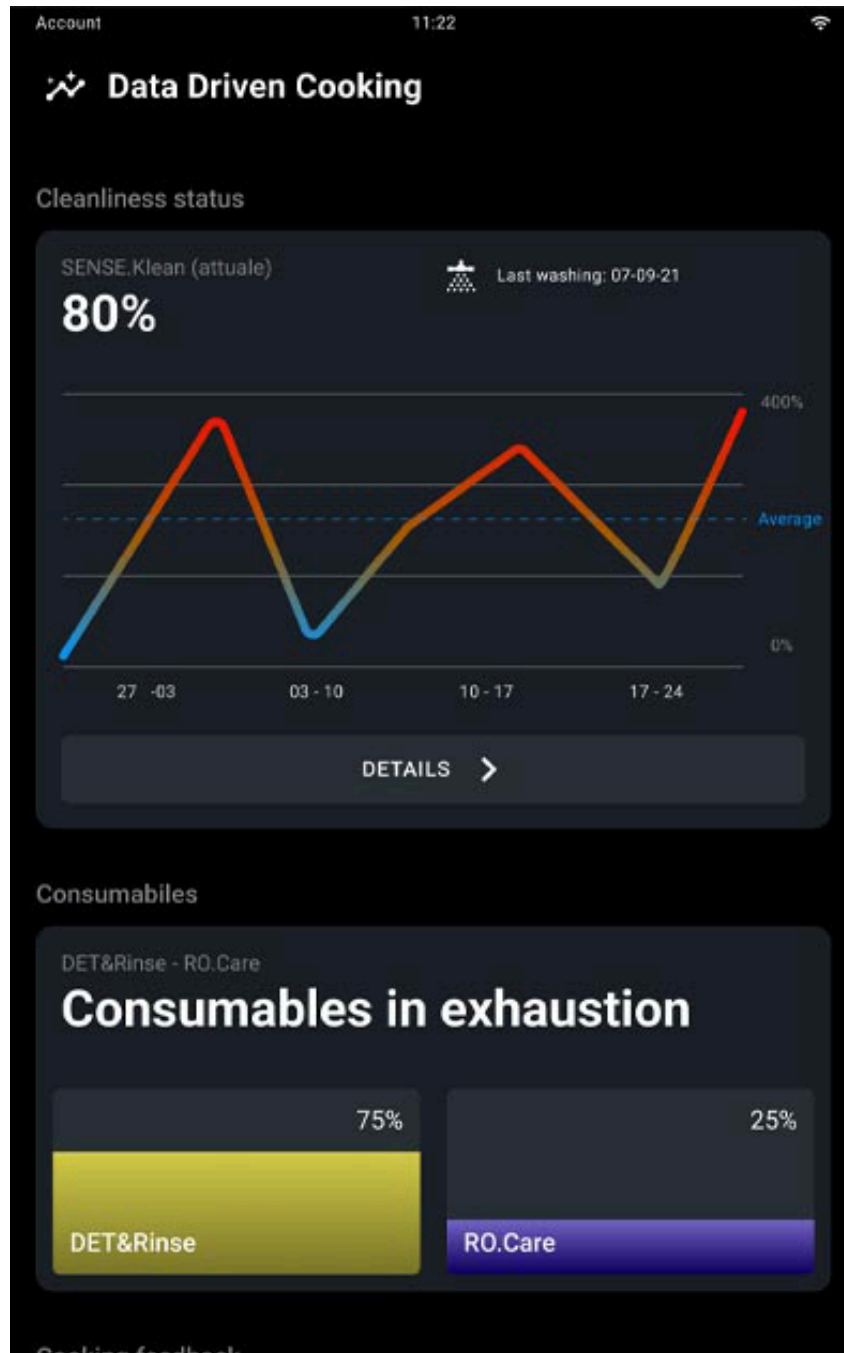

# Cooking reports

You can receive weekly cooking reports that will help you to improve management of your oven's activities.

Information provided:

- average weekly waiting time to end of preheating;
- average weekly time door is open to put something in oven;
- average weekly time spent without load;
- average weekly time door is open during cooking;
- average weekly time door is open at the end of cooking.

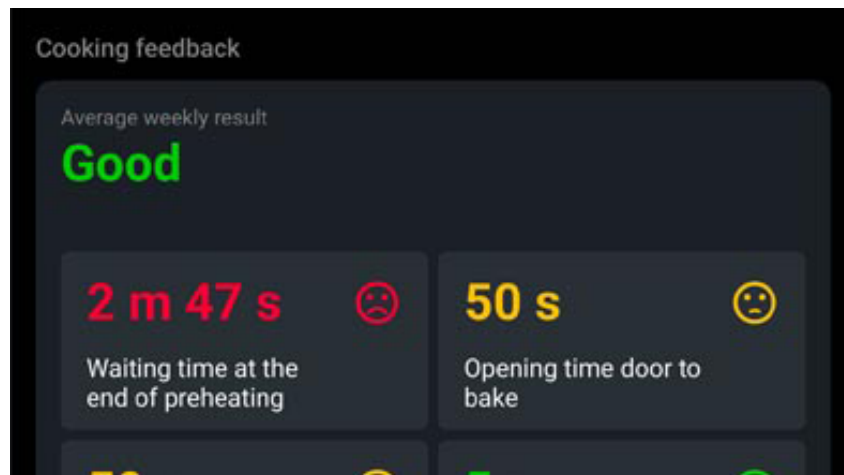

# Apps

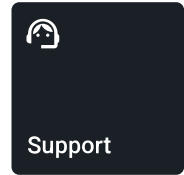

# Support

- [Cooking assistance](#)
  - [Technical assistance](#)
  - [DIGITAL.Training](#)
- 

## Cooking assistance

### COOKING.Concierge

Do you need advice? Do you want to optimize the use of your oven? Do you want to perfect a cooking process? Do you need instructions for a recipe?

If you have activated the Premium\* digital services you can book a Premium call with our Corporate Chefs directly from your oven and talk to them thanks to the internal microphone to receive up to 30 minutes a month of live advice. With the new Badge function you will be able to carry out instructions during the call, while with the Remote Control function you can allow the chef to set your oven remotely.

---

# Technical assistance

## Live Technical Assistance

Do you need help? Book a session with our technical team directly from your oven and talk to them via the internal microphone.

---

## DIGITAL.Training

With the purchase of a Digital.ID™ oven you can receive free Premium base training that will teach you all the tricks to take 100% advantage of your oven from the very first days after installation.

Our Active Marketing Chefs are available remotely to show you everything you need, from basic functions to the most advanced technologies.

---

\* The Digital.ID™ Premium subscription includes HEY.Unox voice assistant, DIGITAL.Training, 30 min/month of COOKING.Concierge cooking support, live technical assistance and all the capabilities of the DDC Enterprise plan.

---

# 8. Oven cleaning and maintenance™

- [Safety information for maintaining the appliance](#)
  - [Cleaning the appliance](#)
  - [Inactivity](#)
  - [Information on disposal and recycling](#)
  - [Small routine maintenance](#)
-

# Safety information for maintaining the appliance



Any routine maintenance must be performed:

- after disconnecting the appliance from the power supply and waiting for the capacitive components to discharge (approx. a few minutes);
- after waiting for the appliance to cool down fully;
- in perfect psychophysical shape;
- after putting on suitable personal protective equipment (e.g. heat-resistant rubber gloves, eye protection, dust mask (optional), etc.).

Carefully read the product safety data sheet before handling and using the detergent. Never touch the detergent with bare hands. The detergent must not come into contact with the skin, eyes or mucous membranes. In case of contact with the detergent, follow the instructions on the safety data sheet.

When cleaning any component or accessory NEVER use:

- abrasive, pointy or sharp tools or cloths (abrasive sponges, scrapers, steel-bristled brushes, etc.);
- steam or pressurised water jets;
- abrasive or powder detergents;
- alkaline, aggressive, caustic or corrosive detergents (e.g. hydrochloric/muriatic or sulphuric acid or caustic soda).

These substances could cause permanent damage to the appliance surfaces and catalysts. Never use these substances when cleaning the appliance substructure or the floor under the appliance. The volatile emissions from these compounds may still cause damage.

Do not insert ANYTHING inside the oven during the washing cycle, otherwise the washing is ineffective.

Do not open the oven door during a washing cycle as this could cause injury to eyes, mucous membranes and skin because of contact with the cleaning chemicals used. These chemicals are sprayed by the rotor in the cavity and moved by strong air currents.

Routine cleaning and maintenance must be done by the user and NOT by children, especially where not supervised by an adult.

Do not tamper with the detergent tank, its connections to the oven and the internal and external water circuit for any reason as this could cause a risk of injury or death.

Periodically check for rust stains inside the oven cavity: if any are found, contact a service centre urgently because the water is probably damaging the oven; prompt action will extend the lifespan of the equipment.

---

# Cleaning the appliance

Clean the appliance on a daily basis in order to maintain a good level of hygiene and to prevent the stainless steel from corroding or deteriorating.

---

## Cleaning the plate, trays, seal

- Wait for the appliance to cool down fully;
- open the oven door and remove plate "A" and/or baking trays. Wash the plate/trays using a soft sponge and warm, soapy water. Rinse and dry them carefully;
- clean seal "B" using a soft cloth dampened in warm, soapy water.



---

# Clean the air filter and tray

- Remove air filter “C” from its magnetic housing and apply UNOX’s SPRAY&Rinse detergent to the whole surface;
- leave for 10 minutes. Rinse thoroughly and dry with a clean cloth. Do not wash the air filter in the dishwasher;
- put the filter back in place. SPEED-X™ does not work without the suction filter. There is a sensor to detect when it is there and warn you to put it back if it is not. The filter must be completely dry before starting the appliance;
- if necessary, remove any residue from tray “D” and clean it using a soft cloth dampened with warm, soapy water.

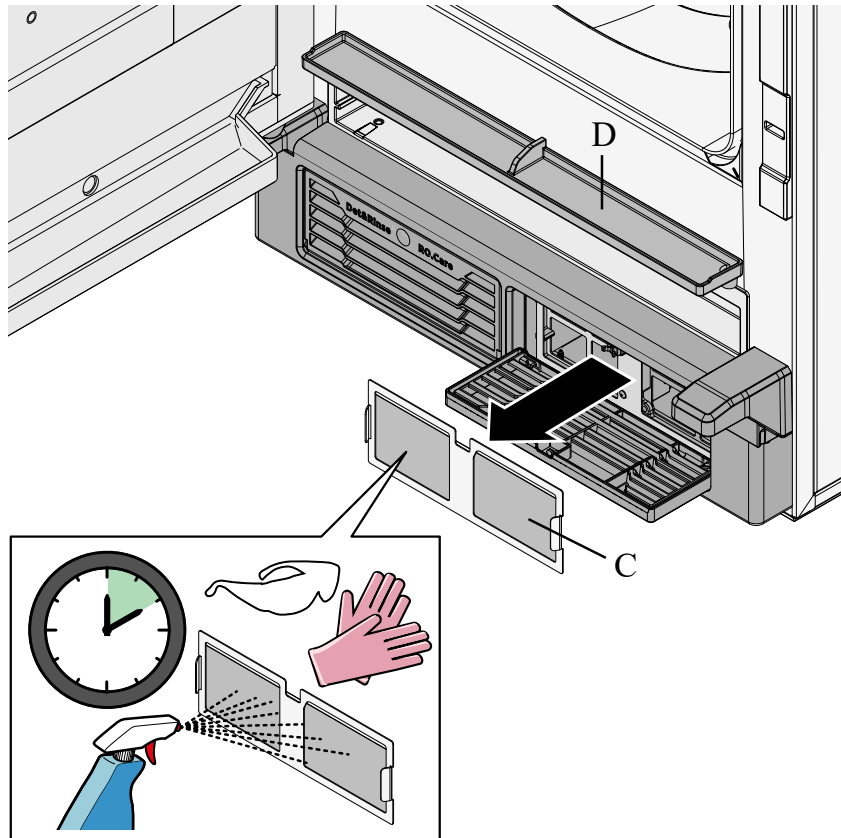
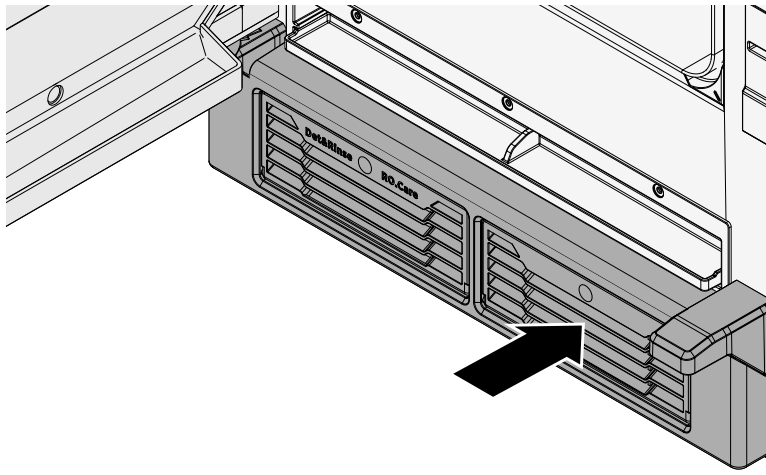

# Cleaning the external parts

- Wait for the appliance to cool down fully;
  - close the oven door and clean the external steel surfaces with a soft cloth, dampened with soapy water. Take care to avoid seepage under the control panel;
  - rinse and dry carefully. Wipe steel surfaces regularly with a soft cloth doused in Vaseline oil to protect them.
- 

# Cleaning the control panel

Clean the control panel with a soft cloth and a little detergent designed for cleaning glass. For how to clean, follow the detergent manufacturer's instructions.

---

# Cleaning the oven cavity

## **Manual cleaning (method not recommended)**

- Wait for the appliance to cool down fully;
- spray a suitable amount of UNOX SPRAY&Rinse onto steel surfaces, without using too much (during these operations wear personal protective equipment);
- DO NOT spray the product on the door seal as this may cause damage over time. By using this detergent, you are guaranteed excellent cleaning results. The product is fully compatible with the materials this appliance is made from. Alternatively, only use warm soapy water;
- then, rinse carefully and thoroughly with a damp cloth to remove any traces of detergent. Dry with a clean cloth or kitchen roll.

## Use of automatic wash programs (recommended mode)

See how to start [automatic wash programs](#) here.

See how to [refill the detergent here](#).

---

# Inactivity

During periods of inactivity, unplug the appliance from the electricity and water supplies (if applicable). Rub a soft cloth lightly doused with Vaseline oil over all stainless steel surfaces and leave the appliance door slightly open.

Before reusing the appliance:

- thoroughly clean the appliance and accessories - see [how to clean your appliance](#) here;
- reconnect the appliance to the electrical and water supply (if applicable);
- inspect the appliance before using it again;
- restart the appliance for at least 50 minutes without any food inside and with the microwave set to 0%.

To ensure that the appliance is in perfect condition in terms of use and safety, maintenance and inspections should be performed at least yearly by authorised service centre.

Find scheduled and preventive maintenance programs on the [UNOX.MyCare](#) & [UNOX.MyCare CONNECT](#) website. These are designed to guarantee high standards of quality and efficiency in UNOX ovens over time, and to avoid any unexpected hitches throughout the year.

---

# Information on disposal and recycling

Pursuant to article 13 of Italian Legislative Decree 49 of 2014 “Implementation of the WEEE Directive 2012/19/EU on waste electrical and electronic equipment”

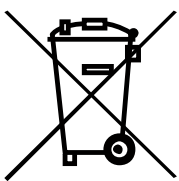

The crossed-out wheeled bin symbol specifies that the product was placed on the market after 13 August 2005 and that at the end of its useful life it should be collected separately and not disposed of with other waste. All appliances are made with recyclable metal materials (stainless steel, iron, aluminium, galvanized steel, copper, etc.) in percentages above 90% by weight. Before disposal, ensure the appliance is unusable by removing the power cable and all compartment or cavity closure devices (where present). At the end of its useful life, the product must be disposed of in such a way as to reduce any negative impact on the environment and make efficient use of available resources. Prefer prevention, preparation for reuse, recycling and reclamation, and remember “the polluter pays”. Please remember that illegal or incorrect disposal of the product incurs penalties, as provided for by current legislation.

---

## **Information on disposal in Italy**

In Italy, WEEE appliances must be delivered to:

- recycling centres (also known as waste disposal sites/facilities)
- the dealer from whom the new appliance is purchased, who is required to collect them free of charge (“one-for-one” collection).

---

## **Information on disposal in European Union countries**

The EU Directive on WEEE appliances has been implemented differently by each country. Therefore, if you want to dispose of this appliance, we recommend you contact your local authority or dealer for information on the correct disposal method.

---

# Small routine maintenance

## Refilling Det&Rinse

A note on the display tells you when you need to refill the Det&Rinse tank.

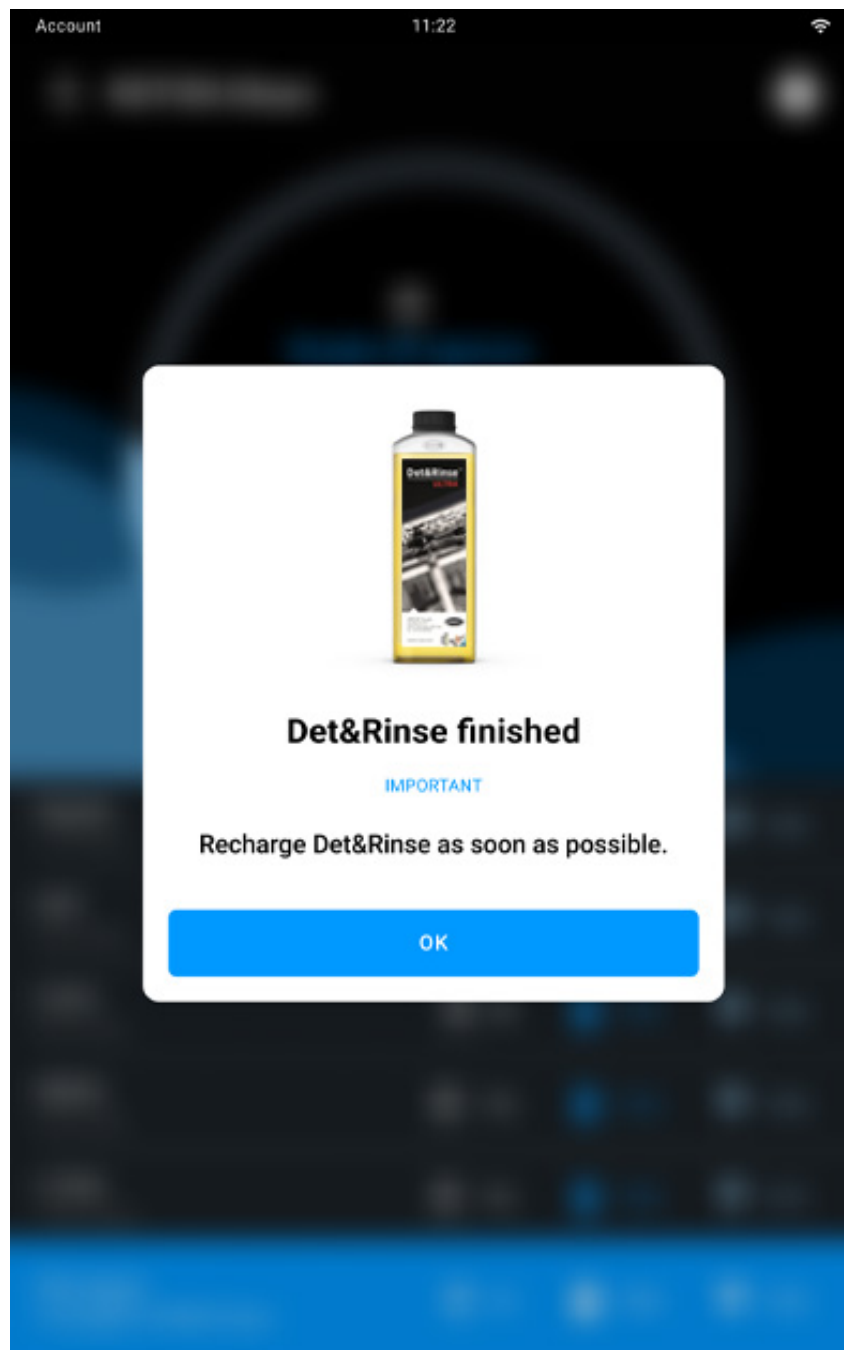

You must only refill the tank with 1 litre bottles of UNOX Det&Rinse™ Ultra detergent, the only one approved and tested for washing the oven cavity.



Wear gloves to prevent your hands from coming into direct contact with the detergent. The detergent must not come into contact with the skin, eyes or mucous membranes. In case of contact with the detergent, follow the instructions on the safety data sheet.

- press and release the tank cover and take out the tank;

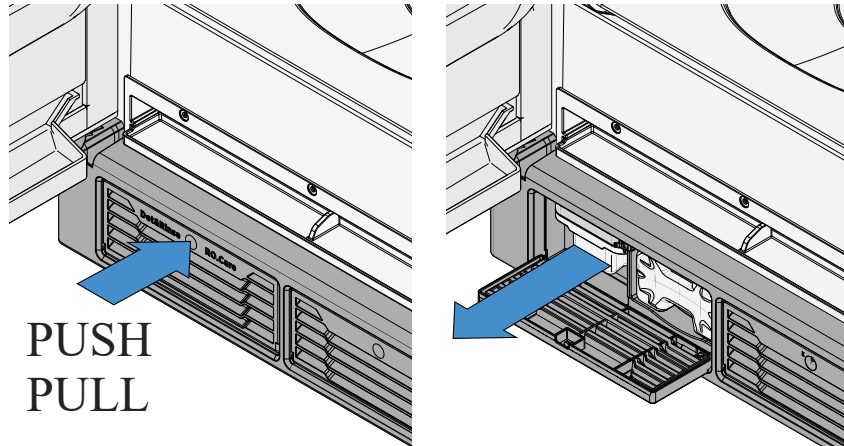

- remove the cap from the UNOX Det&Rinse™ Ultra bottle, holding it with the cap facing upwards; DO NOT remove or pierce the protective film;

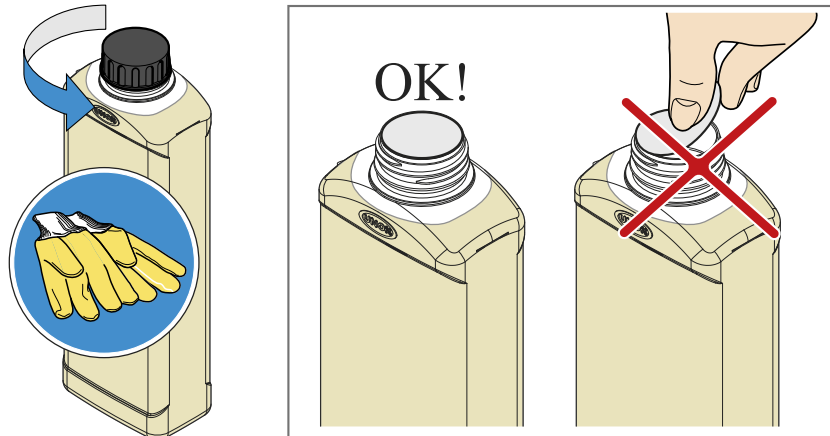

- check that the protective film is intact and undamaged. Turn the bottle upside down and screw it onto the tank; a pin will break the protective film, which allows the detergent to pass safely into the tank.



- When the bottle is completely empty, remove it, making sure it doesn't drip; dispose of it as prescribed by current regulations.

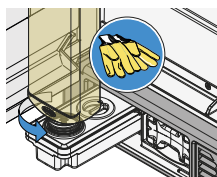

Put the tank back in until it can go no further. Dispose of the gloves without touching the areas wet with detergent.

# Replacing the RO.Care filter

The oven features an RO.Care softener filter that must be replaced once a year or after the treatment of a number of litres calculated using this formula:

Litres (L) =  $13000 \mid 343.4 \text{ Us Gal} / \text{Temporary hardness (}^\circ\text{DH)}$  in relation to the hardness of the customer's mains water.

In both cases a note on the display tells you when you need to replace it.

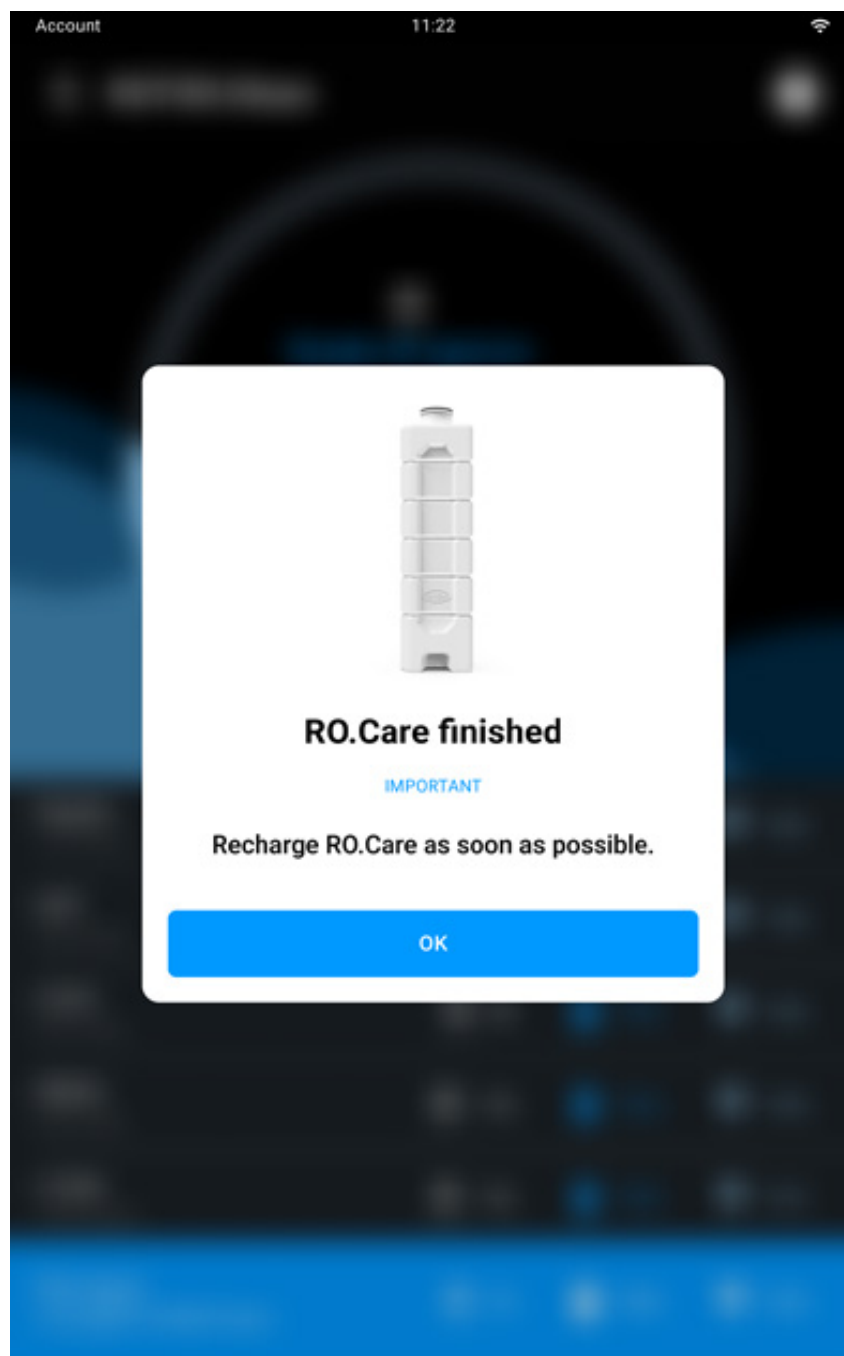

- press and release the RO.Care softener filter cover and take out the empty filter by pulling it outwards;

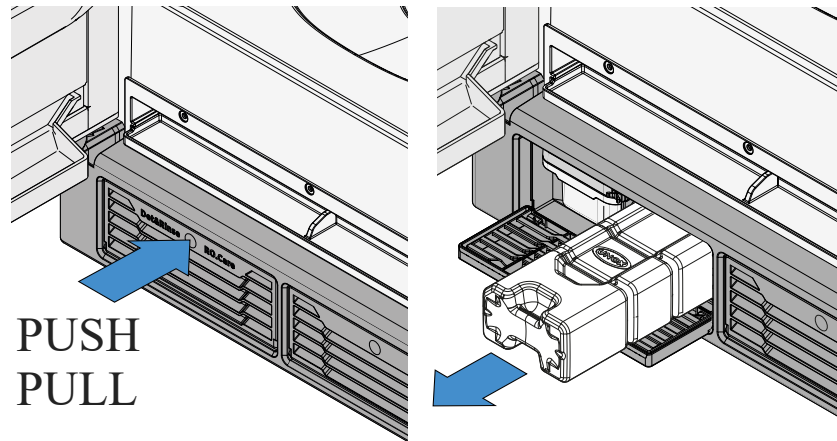

- remove the protective cover from the new filter;
- insert the new filter, making sure that you insert it in the correct direction.

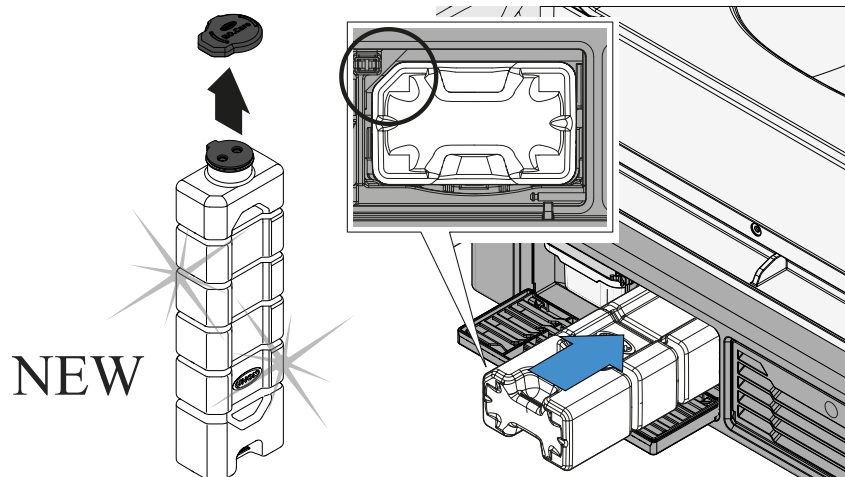

# 9. Using the oven with the Digital.ID™ app

- [Getting the Digital.ID™ app](#)
  - [Creating a Digital.ID™ account](#)
  - [Logging in to Digital.ID™](#)
  - [Connecting your ovens](#)
  - [Nav Bar Operation](#)
  - [List of ovens](#)
  - [Account and settings](#)
-

# Getting the Digital.ID™ app

Go to the store on your device (Play Store on Android or App Store on iOS), search for the **Digital.ID™ app** and download it.

---

## Creating a Digital.ID™ account

To create an account:

- go into the Digital.ID™ App, scroll through the images or tap **SKIP TO LOGIN**;
  - tap **REGISTER** and choose whether to continue registration with **GOOGLE, FACEBOOK OR APPLE**;
  - enter the data requested (basic information); tap **CONTINUE** to continue filling it in (company information and professional profile);
  - when you've finished filling in the details, a confirmation process will be sent to the email address you entered: follow the instructions to complete account registration. If you don't receive an email, check your spam box.
-

# Logging in to Digital.ID™

- Open the Digital.ID™ App, tap LOGIN;
- on the screen that appears, enter your EMAIL address and the PASSWORD you entered when you created your Digital.ID™ account, then tap LOGIN: welcome to the digital world!

If you have already connected your ovens, after login a list of them will be displayed; see how to [display and manage the list of ovens](#) here.

If you haven't connected an oven yet, see how to [connect your ovens](#) here.

---

## Connecting your ovens

The first time you log in to the account you have created, you need to connect your ovens so as to be able to display, monitor and manage them from the Digital.ID™ App.

Before connecting them, we advise you to try our virtual oven so as to test the process without worrying about making a mistake.

# Trying a virtual oven

- Tap TRY A VIRTUAL OVEN;
  - scroll through the images of ovens until you see the model you are interested in and START THE DEMO;
  - the Home Page of the virtual oven will appear; if you want, you can explore all its functions or you can display a list of virtual ovens, by tapping the ovens button  on the bottom left. See how to [display and manage the list of ovens](#) here.
- 

## Connecting your oven with pairing



- Tap the CONNECT YOUR OVEN button; with your device, scan the QR code that appears on the oven display or, alternatively, tap ENTER CODE and enter the **serial number** and the **oven's pin** manually (they are both underneath the QR code);
- enter the **name** that you want to assign to the oven. This will help you to identify it if you have to connect more than one. SAVE the name entered.

If you have more than one UNOX oven, repeat this process for each of them: then they will all be shown on the list of ovens. See how to [display and manage a list of ovens](#) here.

---

# Nav Bar Operation

The Nav Bar lets you quickly navigate in the Digital.ID™ App:

- the OVENS  button on the left lets you [display and manage the list of ovens](#);
- the ACCOUNT  button on the right lets you access your account and if necessary edit it. See how to [manage your account](#) here.

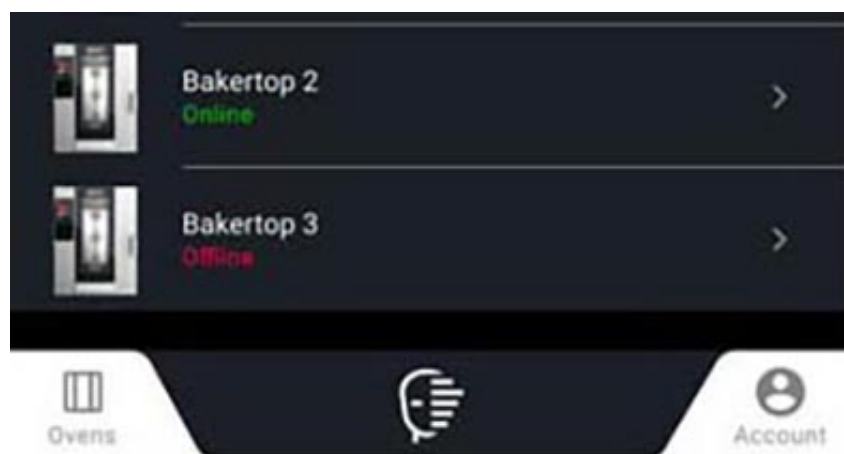

If you have selected an oven and are displaying its Home Page, the Nav Bar allows you to:



HOME button: access the oven's Home Page;



START/STOP button: start up or stop an activity, for example a cooking cycle;



CUSTOM button: access the system [settings](#).

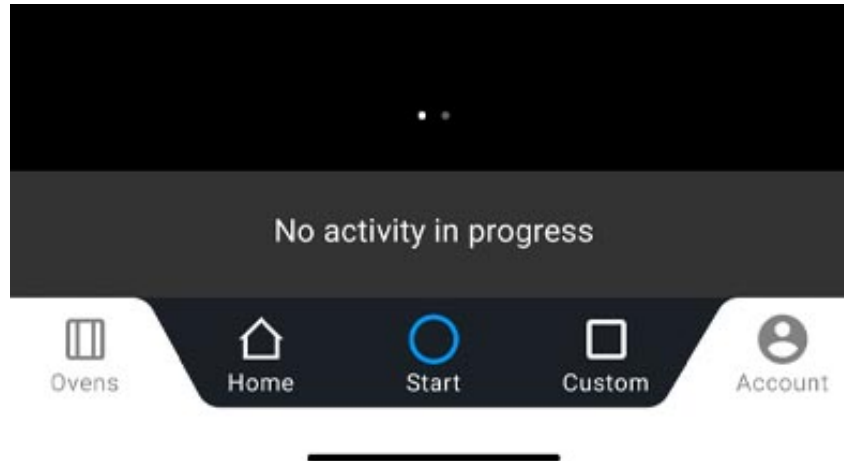

---

## List of ovens

The list of ovens contains all the ovens you have connected through pairing. See how to [connect your oven through pairing](#) here.

## Landing page display and explanation

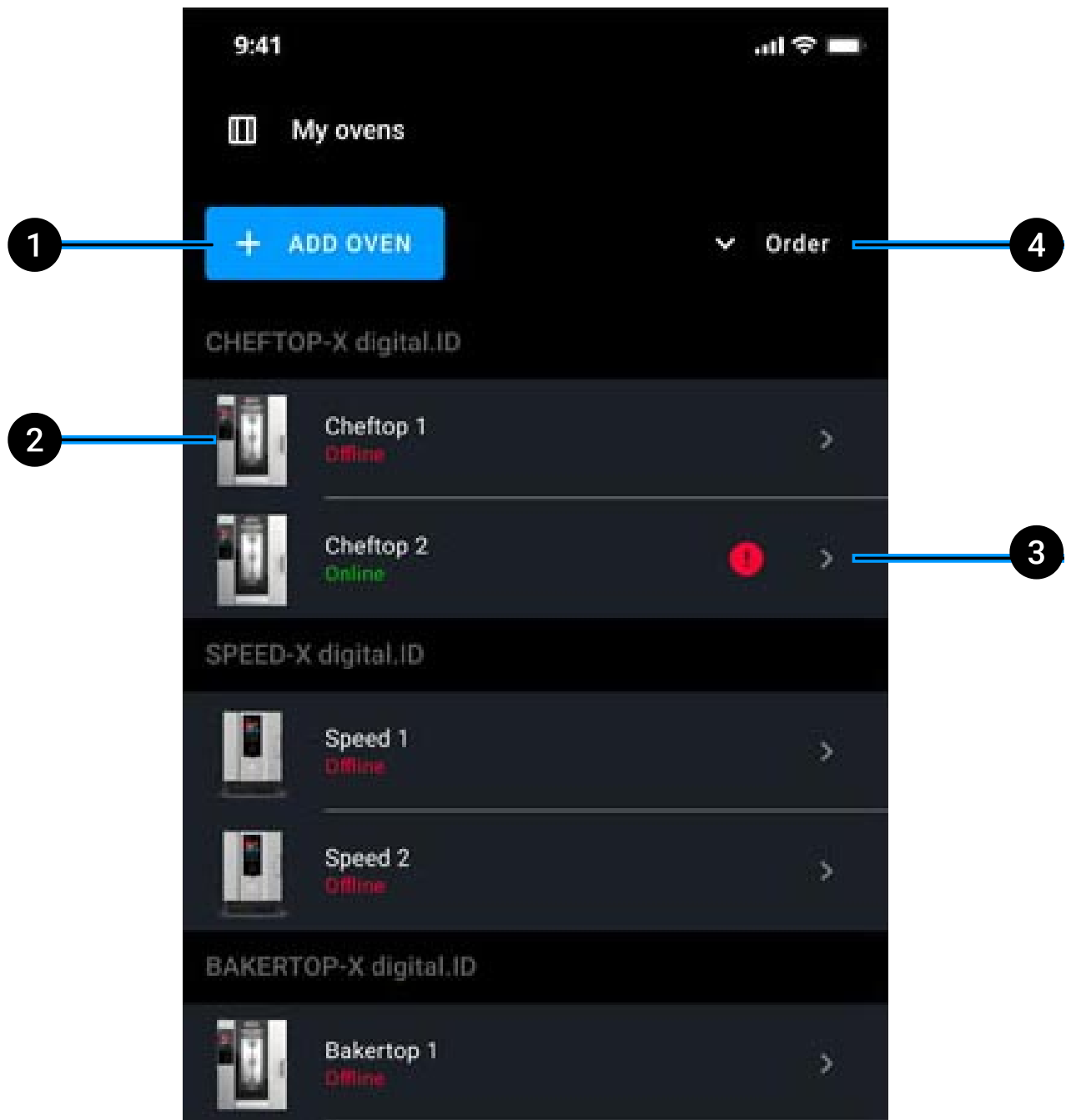

- 1 **add** a new oven to the list;
- 2 **oven name and status** (on-line, off-line): tap the name of the oven to open its Home Page. If it's online, you can control it from the [Digital.ID™ App](#); if it's offline, some functions will be deactivated (greyed out), while activities that are active and can be edited will be synchronised once the oven is online again;
- 3 add oven with **alarm** status: we recommend you check what is causing the alarm;
- 4 **order** ovens by range, date of connection or use; if there are ovens with an alarm status, they will always come first in the order.

---

## Editing your list of ovens

### Going into EDIT mode

Tap and hold down the name of an oven.

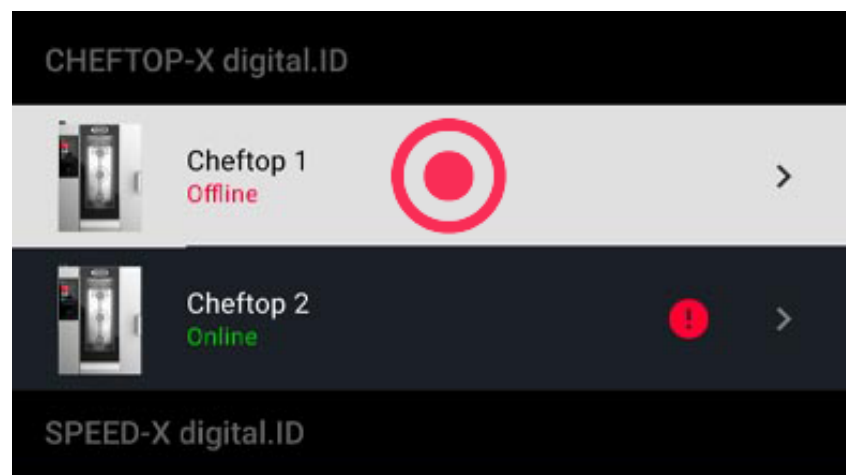

## Renaming an oven

- Go into EDIT mode. See how to [go into EDIT mode here](#);
- press RENAME , type the new name of the oven and confirm with APPLY.

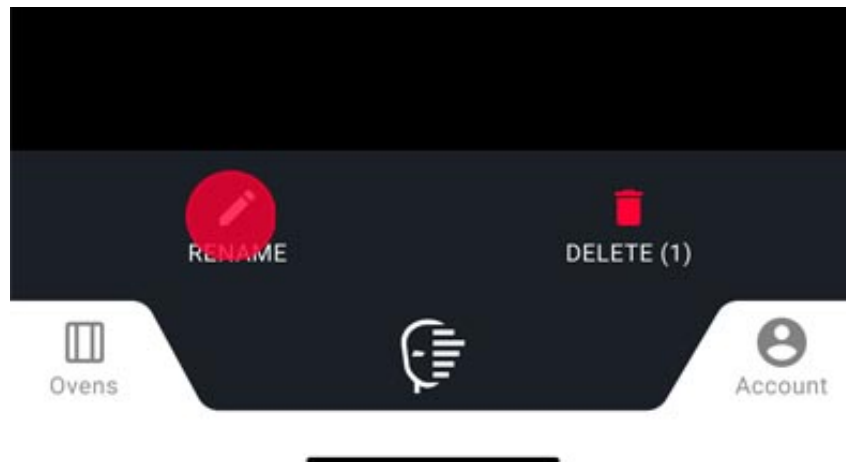

## Deleting an oven

- Go into EDIT mode. See how to [go into EDIT mode here](#);
- press DELETE  and confirm with DELETE.

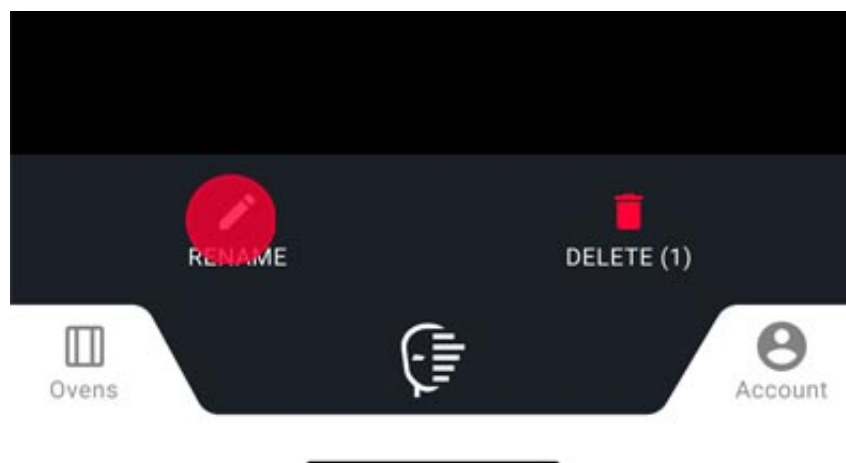

---

# Account and settings

# Access account

Tap account  on the right.

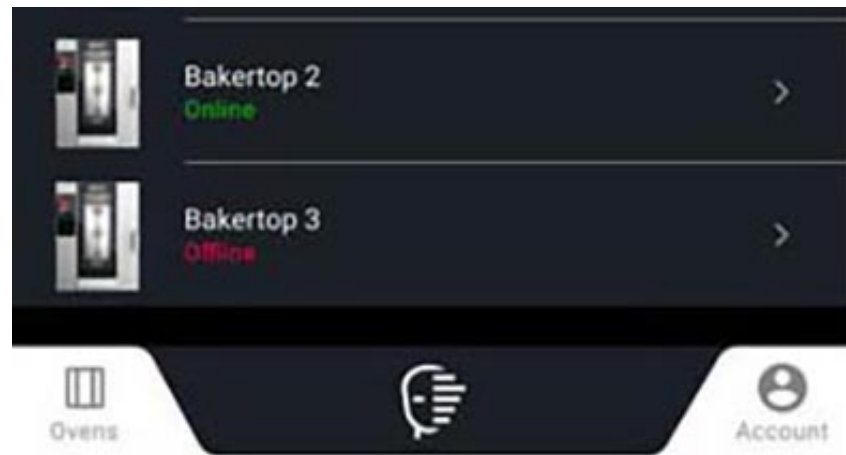

---

# Account settings

9:41













 Account



CHEFTOP-X di Mario  
Mario's Restaurant

Account settings

-   Account informations 
-   Notification management
-   Subscription
-   Payment metods and billing settings
-  Profiles

Personal images

 Personal gallery

Security

 Blocks and security

 Privacy

  
Ovens



  
Account

- 1 set **basic** information, **company information**, **professional profile**, the **language** and the **unit of measurement**;
- 2 decide whether to receive **notifications**;
- 3 **manage your subscription** - Basic or Premium;
- 4 **set your predefined payment method**;
- 5 **manage the profiles** of the oven users and know their status.

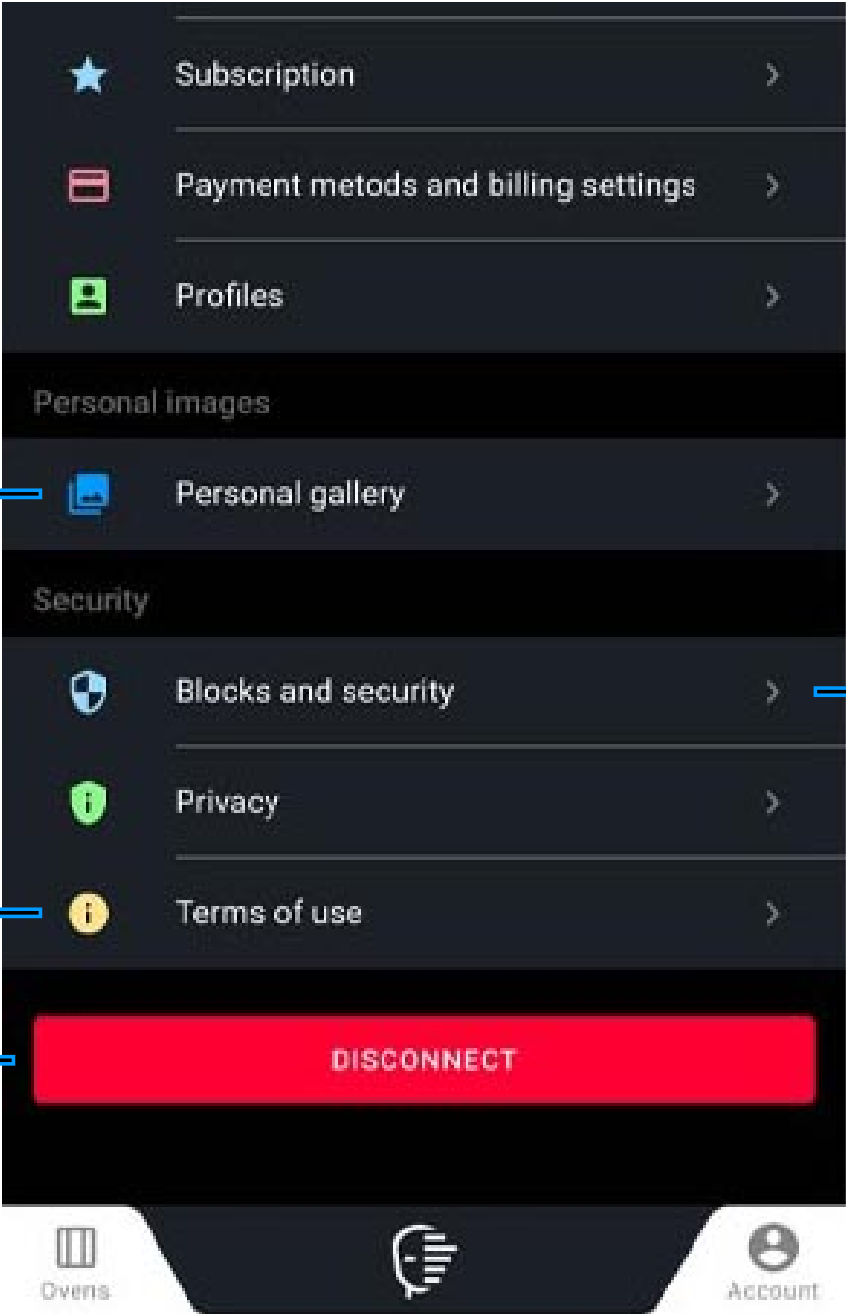

6

7

8

9

- 6 **upload** a personal picture by taking a photo or selecting one from the gallery on your device. The photos you upload will be stored in the recipe picture gallery on your oven; in this way you will be able to use them when you save a personal recipe;
  - 7 access the **security and blocking settings** of your account and the oven; in this section you can change the account password or set a PIN to block functions, for example starting a cooking process or connecting other ovens;
  - 8 list the **terms of use** of the oven;
  - 9 **disconnect** your device from the Digital.ID™ app.
-

# 10. Hey UNOX!

- [What Voice Control can do](#)
  - [Activating Unox Voice Control](#)
  - [Editing UNOX Voice Control settings](#)
-

# Voice Control

"Hey Unox, preheat to 180°C".

The **Voice Control** technology can recognise your voice, interpret your requests, and make the oven act accordingly. This enables you to give commands even when your hands are full.

## What UNOX Voice Control can do

Unox Voice Control can:

- **start a program** saved in the Library or Chefunox app
  - **start a manual or preset program** and help you to set its parameters (provided your requests are included in the ranges anticipated by the preset program you have chosen);
  - **set or add timers** in the MULTI.Time - MULTI.Speed apps or in a cooking cycle in progress (in this case, add timer widgets on the Home Page);
  - **start** a wash;
  - **tell you what time it is.**
-

# Activating UNOX Voice Control

To activate or deactivate the technology, tap the voice  button



---

## Editing UNOX Voice Control settings

Go to [settings](#) > Voice control > language.

---

# 11. Restarting, updating and resetting

- [Turning the oven on and off](#)
  - [Updating the software](#)
  - [Restoring factory settings](#)
-

# Turning the oven on and off

To turn the oven on and off, tap the ON/OFF button on the panel. After about 20 seconds, the Home Page will appear.

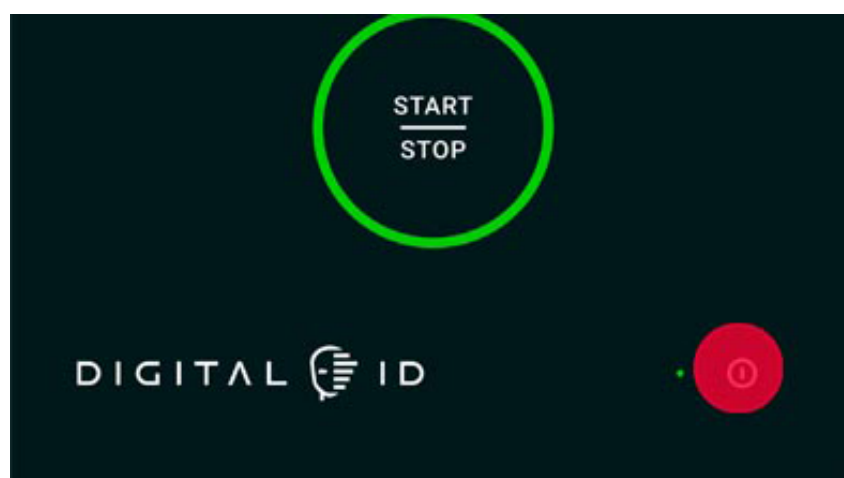

---

## Updating the software

Go to [settings](#) > Updating software > Update the software. You can only update the software if there are no cooking or washing programs in progress; after updating you will be asked to turn the oven off.

---

# Restoring factory settings

When starting the oven, tap the display repeatedly 5 times to turn on reset mode. You will be able to:

- **start** the oven normally (start oven);
  - **restore** the previous version of the software (restore previous software version);
  - **restore** the oven to factory settings (factory reset);
  - **access** advanced commands (advanced options for Unox Service).
-

# 12. Assistance and support

- [What to do if the oven isn't working](#)
  - [Technical assistance](#)
  - [LONG.Life - LONG.Life 5](#)
  - [Contact technical support](#)
  - [Manufacturer's information](#)
-

# What to do if the oven isn't working

If the oven isn't working, disconnect the appliance from any electrical and plumbing connections (where applicable) and contact an authorised [UNOX Technical Assistance centre](#), providing the following information:

- date of purchase;
- any warning messages that appear on the display;
- the appliance data on the serial plate.

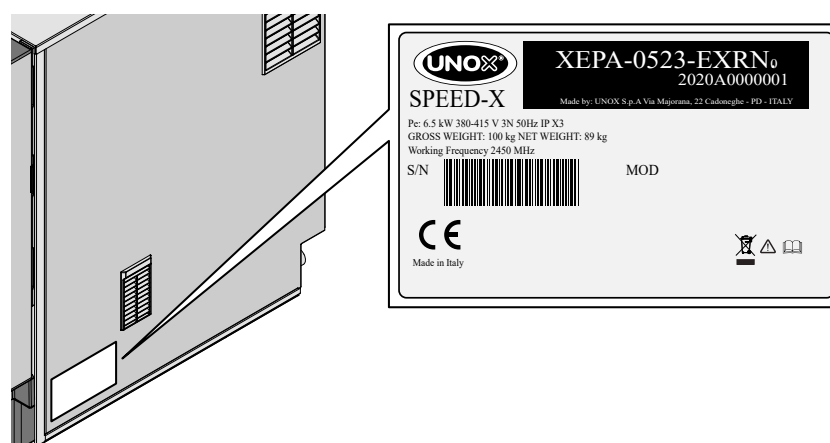

# Technical assistance

All our products are designed to last a long time, to assist you with the best possible technology and to make you capable of facing any challenge. However, unexpected events may arise; in these cases, the network of UNOX Authorized and Certified Technical Assistance Centers is always at your disposal to minimize downtime.

Click here to find [UNOX Authorized Technical Assistance Centers](#)

Find scheduled and preventive maintenance programs on the [UNOX.MyCare](#) & [UNOX.MyCare CONNECT](#) website.

---

## LONG.Life - LONG.Life 5

With LONG.Life, you have the specialized assistance of our technicians and a 12-month warranty to cover labor and spare parts.

With UNOX LONG.Life5 you have the possibility to extend the warranty up to 5 years or 12,000 hours of use on spare parts and 24 months or 12,000 hours of use on labour. Contact UNOX for more information.

---

# Contact technical support

If you are a Premium customer \* you can call our technical team directly from your oven and speak to our operators via the internal microphone. Moreover, thanks to the built-in chat and camera function of the Digital.ID™ app you can send messages and images to help the team diagnose and resolve your doubts more quickly and accurately.

\* The Digital.ID™ Premium subscription includes HEY.Unox voice assistant, DIGITAL.Training, 30 min/month of COOKING.Concierge cooking support, live technical assistance and all the capabilities of the DDC Enterprise plan.

---

## Manufacturer's information

UNOX S.p.A Via E. Majorana, 22  
35010 Cadoneghe (PD) Italy  
Tel (+39) 049 86.57.511  
Fax (+39) 049 86.57.555  
[info@unox.com](mailto:info@unox.com)  
[www.unox.com](http://www.unox.com)

---

# 13. Copyright

Copyright 2021 UNOX S.p.A. All rights reserved. Companies' Register Padua n° 04230750285 - Economic Administrative Index Padua 372835 - Share capital € 5,000,000 fully paid up - VAT No. / Tax Code 04230750285

## **LI2700A0**

All images used are for illustrative purposes only.  
All features indicated in this catalogue may be subject to change and could be updated without notice.

---